

Metalocene Derivatives of Early Transition Metals. Part 4.¹ Chemistry of the Complexes $[M(\eta\text{-C}_5\text{H}_5)_2\text{RR}']$ [$M = \text{Ti, Zr, or Hf; R} = \text{CH}_2\text{M}'\text{Me}_3$ ($M' = \text{C, Si, Ge, or Sn}$) or $\text{CH}(\text{SiMe}_3)_2$; $\text{R}' = \text{Cl or alkyl}$] and the X-Ray Structures of $[\text{Zr}(\eta\text{-C}_5\text{H}_5)_2(\text{CH}_2\text{M}'\text{Me}_3)_2]$ ($M' = \text{C or Si}$)

By John Jeffery, Michael F. Lappert,* N. Tuyet Luong-Thi, and Maurice Webb, School of Molecular Sciences, University of Sussex, Brighton BN1 9QJ

Jerry L. Atwood* and William E. Hunter, Department of Chemistry, University of Alabama, Alabama 35486, U.S.A.

The metallocene(IV) halogeno-alkyls $[M(\eta\text{-C}_5\text{H}_5)_2\text{RX}]$ [type (i) $\text{R} = \text{CH}_2\text{SnMe}_3$, $\text{X} = \text{Cl or Br}$, $\text{M} = \text{Ti}$ (also $\text{X} = \text{I}$), Zr , or Hf ; type (ii) $\text{R} = \text{CH}_2\text{SiMe}_3$, $\text{X} = \text{Cl or Br}$, $\text{M} = \text{Ti, Zr, or Hf}$; type (iii) $\text{R} = \text{CH}_2\text{GeMe}_3$, $\text{X} = \text{Cl, M} = \text{Ti}$] have been prepared either by interaction of the appropriate Grignard reagent and $[M(\eta\text{-C}_5\text{H}_5)_2\text{Cl}_2]$ or from $[M(\eta\text{-C}_5\text{H}_5)_2\text{RCl}]$ and $\text{Mg}(\text{CH}_2\text{SnMe}_3)\text{X}$ (Cl-X exchange). Metallocene(IV) dialkyls $[M(\eta\text{-C}_5\text{H}_5)_2\text{RR}']$ [type (iv) $\text{R} = \text{CH}_2\text{SnMe}_3 = \text{R}'$, $\text{M} = \text{Ti, Zr, or Hf}$; type (v) $\text{R} = \text{CH}_2\text{SnMe}_3$, $\text{R}' = \text{CH}_2\text{SiMe}_3$, $\text{M} = \text{Ti, Zr, or Hf}$; type (vi) $\text{R} = \text{CH}_2\text{CMe}_3 = \text{R}'$, $\text{M} = \text{Ti or Zr}$; type (vii) $\text{R} = \text{CH}_2\text{SnMe}_3$; $\text{R}' = \text{CH}_2\text{CMe}_3$, CH_2GeMe_3 , or Me ; $\text{M} = \text{Ti}$; type (viii) $\text{R} = \text{CH}_2\text{SiMe}_3$, $\text{R}' = \text{CH}_2\text{GeMe}_3$, $\text{M} = \text{Ti}$; type (ix) $\text{R} = \text{CH}(\text{SiMe}_3)_2$; $\text{R}' = \text{Me, Et, Pr}^n$, CH_2SiMe_3 , or Ph ; $\text{M} = \text{Zr}$] have been synthesised by reaction of (a) [for type (v)] $[M(\eta\text{-C}_5\text{H}_5)_2\text{Cl}_2]$ with $2\text{Mg}(\text{CH}_2\text{SnMe}_3)\text{X}$ ($\text{X} = \text{Cl or Br}$) or (b) $[M(\eta\text{-C}_5\text{H}_5)_2\text{RX}]$ with LiR' . Also obtained are $[\text{Ti}(\eta\text{-C}_5\text{H}_5)_2\text{Cl}(\text{OCH}_2\text{SiMe}_3)]$ and $[\{\text{Zr}(\eta\text{-C}_5\text{H}_5)_2[\text{CH}(\text{SiMe}_3)_2\text{H}]_2\}]$, the latter from $[\text{Zr}(\eta\text{-C}_5\text{H}_5)_2\{\text{CH}(\text{SiMe}_3)_2\text{Cl}\}]$ and $\text{Li}[\text{AlH}_4]$ or $[\text{Zr}(\eta\text{-C}_5\text{H}_5)_2\text{Cl}_2]$ and successively $\text{Li}[\text{AlH}(\text{O}i\text{Bu})_3]$ and $\text{Li}[\text{CH}(\text{SiMe}_3)_2]$. The reaction of an equimolar portion of HCl in OEt_2 and $[\text{Ti}(\eta\text{-C}_5\text{H}_5)_2(\text{CH}_2\text{SnMe}_3)\text{Cl}]$ gives predominantly the products of $\text{CH}_2\text{-SnMe}_3$, rather than Ti-CH_2 , scission. By contrast, the dialkyls $[M(\eta\text{-C}_5\text{H}_5)_2\text{RR}']$, containing one or two CH_2SnMe_3 ligands, give largely RH or $\text{R}'\text{H}$ and $[M(\eta\text{-C}_5\text{H}_5)_2\text{Cl}(\text{R}' \text{ or } \text{R})]$; the relative ability of R as a leaving group decreases in the sequence $\text{CH}_2\text{SnMe}_3 > \text{CH}_2\text{CMe}_3 > \text{CH}_2\text{SiMe}_3 > \text{CH}_2\text{GeMe}_3 > \text{CH}_3$, the distinctions being more marked for Ti than Zr or Hf . The dialkyls are generally stable when heated at 80°C in PhMe , except for the titanium complexes; $[\text{Ti}(\eta\text{-C}_5\text{H}_5)_2(\text{CH}_2\text{M}'\text{Me}_3)_2]$ ($M' = \text{Si or Ge}$) gives $\text{M}'\text{Me}_4$ as the sole volatile product, with t_1 110 ($M' = \text{Si}$) or 140 min ($M' = \text{Sn}$). Treatment of $[\text{Zr}(\eta\text{-C}_5\text{H}_5)_2\text{RX}]$ [type (ix)] in C_6H_6 with CO under ambient conditions affords the appropriate η^2 -acyl $[\text{Zr}(\eta\text{-C}_5\text{H}_5)_2(\eta^2\text{-COR})\text{X}]$ [type (x), $\text{R} = \text{CH}_2\text{CMe}_3$ or CH_2SiMe_3 , $\text{X} = \text{Cl or R}$; or type (xi), $\text{R} = \text{CH}(\text{SiMe}_3)_2$, $\text{X} = \text{Me}$]; the formation of type (xi), rather than the isomer resulting from CO insertion into the less hindered Zr-Me bond, is noteworthy. A single-crystal X-ray diffraction study has been carried out on $[\text{Zr}(\eta\text{-C}_5\text{H}_5)_2(\text{CH}_2\text{M}'\text{Me}_3)_2]$ [$M' = \text{C, (28) or Si, (42)}$]. Crystals of complex (28) are tetragonal, space group $I\bar{4}$, with $a = 9.142(4)$, $b = 9.142(4)$, $c = 23.326(9)$ Å, $\beta = 90^\circ$, and $Z = 4$. Crystals of (42) are monoclinic, space group $P2_1/n$, $a = 13.745(6)$, $b = 7.048(3)$, $c = 22.057(9)$ Å, $\beta = 95.65(4)^\circ$, and $Z = 4$. For complex (28), 487 reflections have been considered and the data refined to $R = 0.029$, $R' = 0.032$; for complex (42), 2 688 independent reflections led to $R = 0.029$, $R' = 0.033$. The slightly larger steric requirement of the neopentyl ligand compared with $\text{-CH}_2\text{SiMe}_3$ manifests itself in a larger $\text{Zr-cyclopentadienyl}$ approach but the Zr-CH_2 bond length is indistinguishable, 2.51(2) Å for (28) and 2.52(2) Å for (42).

The principal objective of the present work was to compare the ligands $\text{-CH}_2\text{M}'\text{Me}_3$ ($M' = \text{C, Si, Ge, or Sn}$) in various ways in the context of the chemistry of the d^0 metallocene(IV) chloro-alkyl and dialkyl complexes $[M(\eta\text{-C}_5\text{H}_5)_2\text{RR}']$. The new compounds have the formulae $[M(\eta\text{-C}_5\text{H}_5)_2(\text{CH}_2\text{M}'\text{Me}_3)\text{X}]$ ($M = \text{Ti, Zr, or Hf}$; $M' = \text{Si, Ge, or Sn}$; $\text{X} = \text{Cl or Br}$), $[M(\eta\text{-C}_5\text{H}_5)_2(\text{CH}_2\text{-SnMe}_3)\text{R}']$ ($\text{R}' = \text{Me or CH}_2\text{M}'\text{Me}_3$, $M' = \text{C, Si, Ge, or Sn}$), $[\text{Ti}(\eta\text{-C}_5\text{H}_5)_2(\text{CH}_2\text{SiMe}_3)(\text{CH}_2\text{GeMe}_3)]$, $[\text{Zr}(\eta\text{-C}_5\text{H}_5)_2\{\text{CH}(\text{SiMe}_3)_2\}\text{R}''']$ ($\text{R}''' = \text{Me, Et, Pr}^n$, CH_2SiMe_3 , or Ph), and some zirconium(IV) acyls $[\text{Zr}(\eta\text{-C}_5\text{H}_5)_2(\text{COR}^1)\text{R}^2]$ [$\text{R}^1, \text{R}^2 = \text{CH}_2\text{CMe}_3, \text{Cl}; (\text{CH}_2\text{CMe}_3)_2, (\text{CH}_2\text{SiMe}_3)_2, \text{ or } \text{CH}(\text{SiMe}_3)_2, \text{Cl}$]. Data on these are collected in Tables 1-4.

The emphasis in this paper is on neopentyl-type ligands $\text{-CH}_2\text{M}'\text{Me}_3$ and $\text{-CH}(\text{SiMe}_3)_2$ ($M' = \text{C, Si, Ge, or Sn}$)² and particularly on $\text{-CH}_2\text{SnMe}_3$.³ Only two compounds were previously known in which there is a transition metal- CH_2SnMe_3 linkage. These were a platinum(II) [equation (1)]⁴ and an iron(II) [equation (2)]⁵ complex. A trimethylstannylmethyl compound of boron had also been reported, $\text{B}(\text{CH}_2\text{SnMe}_3)_3$, equation (3).⁶

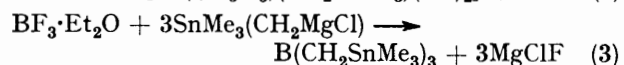
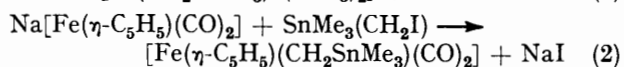
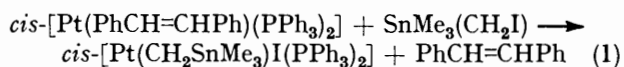

Some indication that the ligand $\text{-CH}_2\text{SnMe}_3$ might possess unusual features was to be found in the earlier literature. Quantitative differences had been noticed in oxidative additions;⁴ e.g. whereas the platinum(II) product of equation (1) was obtained in only 10% yield after a reaction period of 20 days, a 25% yield of the corresponding $\text{Pt}(\text{CH}_2\text{SiMe}_3)$ complex was obtained after 20 h. Qualitative distinctions appeared in the reactions of the halides $\text{M}'\text{Me}_3(\text{CH}_2\text{X})$ ($M' = \text{Sn or Si}$) with metallate anions. Thus, in the reaction between iodomethyltrimethylstannane and (η -cyclopentadienyl)-carbonylmetallate anions of Fe^{II} , Mo^{II} , or W^{II} , the iron(II) alkyl [equation (2)] was produced in 60% yield,⁴ whereas in the other two systems cleavage of the $\text{CH}_2\text{-Sn}$ bond was noted, equation (4) ($M = \text{Mo or W}$);⁷ similar

TABLE 1

Metalocene(IV) halogeno-alkyls, $[\text{Ti}(\eta\text{-C}_5\text{H}_5)_2\text{Cl}(\text{OCH}_2\text{SiMe}_3)]$, and $[\{\text{Zr}(\eta\text{-C}_5\text{H}_5)_2[\text{CH}(\text{SiMe}_3)_2\text{H}\}_2]$, and their characterisation

	[M($\eta\text{-C}_5\text{H}_5$) ₂ RX]			Colour	Analysis (%) ^a		
	M	R	X		C	H	X
(1)	Ti	CH ₂ SnMe ₃	Cl	Bright orange	43.0 (43.0)	5.40 (5.40)	9.30 (9.05)
(2)	Ti	CH ₂ SiMe ₃	Cl	Orange	55.9 (55.9)	6.75 (7.05)	11.7 (11.8)
(3)	Ti	CH ₂ GeMe ₃	Cl	Orange	49.0 (48.7)	6.15 (6.15)	10.3 (10.3)
(4)	Ti	CH ₂ SnMe ₃	Br	Bright orange	38.6 (38.6)	4.95 (4.85)	18.2 (18.3)
(5)	Ti	CH ₂ SiMe ₃	Br	Orange		<i>b</i>	
(6)	Ti	CH ₂ SnMe ₃	I	Red		<i>b</i>	
(7)	Zr	CH ₂ SnMe ₃	Cl	White	38.6 (38.7)	4.95 (4.85)	8.30 (8.15)
(8)	Zr	CH ₂ SnMe ₃	Br	Pale yellow	35.1 (35.2)	4.40 (4.35)	16.7 (16.8)
(9)	Zr	CH ₂ SiMe ₃	Br	Pale yellow		<i>b</i>	
(10)	Hf	CH ₂ SnMe ₃	Cl	White	32.5 (32.2)	4.00 (4.05)	6.90 (6.80)
(11)	Hf	CH ₂ SiMe ₃	Cl	White	39.0 (39.0)	4.90 (4.90)	8.1 (8.2)
(12)	Hf	CH ₂ SnMe ₃	Br	White	29.4 (29.7)	3.65 (3.75)	14.2 (14.1)
(13)	Hf	CH ₂ SiMe ₃	Br	White		<i>c</i>	
(14)	Ti	OCH ₂ SiMe ₃	Cl ^d	Primrose-yellow	52.9 (53.1)	6.70 (6.70)	11.2 (11.2)
	Zr	CH(SiMe ₃) ₂	H ^e	Pale yellow	53.3 (53.5)	7.70 (7.85)	

^a Calculated values are given in parentheses. ^b Not isolated pure. ^c Satisfactory microanalysis. ^d Obtained, inadvertently, from $[\text{Ti}(\eta\text{-C}_5\text{H}_5)_2\text{Cl}_2]$ and $\text{Li}[\text{CH}_2\text{SiMe}_3]$ in wet OEt_2 . ^e Obtained from $[\text{Zr}(\eta\text{-C}_5\text{H}_5)_2\{\text{CH}(\text{SiMe}_3)_2\text{Cl}\}]$ and $\text{Li}[\text{AlH}_4]$, or $[\text{Zr}(\eta\text{-C}_5\text{H}_5)_2\text{Cl}_2]$ and successively $\text{Li}[\text{AlH}(\text{O}i\text{Bu})_2]$ and $\text{Li}[\text{CH}(\text{SiMe}_3)_2]$; m.p. 85–90 °C (decomp.), (dimer –1)⁺ in mass spectrum, dimer by cryoscopy in C_6H_6 (Found: *M*, 774. Dimer requires *M*, 763), $\nu(\text{ZrH})$ at 1590 cm^{-1} .

TABLE 2

Metalocene(IV) dialkyls and their characterisation

	[M($\eta\text{-C}_5\text{H}_5$) ₂ RR']			Colour	Analysis (%) ^a	
	M	R	R'		C	H
(15)	Ti	CH ₂ SnMe ₃	CH ₂ SnMe ₃	Bright yellow	40.6 (40.5)	6.25 (6.05)
(16)	Ti	CH ₂ SnMe ₃	CH ₂ SiMe ₃	Bright yellow	48.6 (48.8)	7.30 (7.30)
(17)	Ti	CH ₂ SnMe ₃	CH ₂ CMe ₃	Dark red	53.4 (53.4)	7.60 (7.55)
(18)	Ti	CH ₂ SnMe ₃	CH ₂ GeMe ₃	Yellow-orange	44.4 (44.3)	6.65 (6.60)
(19)	Ti	CH ₂ SnMe ₃	Me	Bright yellow	48.3 (48.6)	6.85 (6.50)
(20)	Ti	CH ₂ SiMe ₃	CH ₂ GeMe ₃	Primrose-yellow	54.5 (54.5)	8.15 (8.10)
(21)	Zr	CH ₂ SnMe ₃	CH ₂ SnMe ₃	White	37.2 (37.5)	5.65 (5.60)
(22)	Zr	CH ₂ SnMe ₃	CH ₂ SiMe ₃	White	44.7 (44.4)	6.70 (6.65)
(23)	Zr	CH(SiMe ₃) ₂	Me ^b	White	54.2 (54.6)	7.75 (8.10)
(24)	Zr	CH(SiMe ₃) ₂	Et	Pale yellow		<i>c</i>
(25)	Zr	CH(SiMe ₃) ₂	Pr ⁿ ^d	Pale yellow	56.8 (56.9)	8.70 (8.50)
(26)	Zr	CH(SiMe ₃) ₂	CH ₂ SiMe ₃ ^e	White	54.1 (53.9)	8.35 (8.55)
(27)	Zr	CH(SiMe ₃) ₂	Ph ^f	White	60.5 (60.3)	7.15 (7.45)
(28)	Zr	CH ₂ CMe ₃	CH ₂ CMe ₃	Pale yellow		<i>g</i>
(29)	Hf	CH ₂ SnMe ₃	CH ₂ SnMe ₃	White	32.5 (32.5)	5.10 (4.85)
(30)	Hf	CH ₂ SnMe ₃	CH ₂ SiMe ₃	White	37.5 (37.7)	5.70 (5.60)

^a Calculated values are given in parentheses. ^b M.p. 190–193 °C. ^c Not isolated pure. ^d M.p. 88–89 °C. ^e M.p. 53–55 °C. ^f M.p. 116–118 °C. ^g Satisfactory microanalysis.

TABLE 3

Zirconocene(IV) acyls and their characterisation

Complex	Colour	Analysis (%) ^a		M.p. (°C) ^b	I.r.: $\nu(\text{CO})$ (cm^{-1}) ^c	¹ H n.m.r. chemical shifts ^d (M' = C or Si)				
		C	H			C_5H_5	COCH	COCHM'-(CH ₃) ₃	ZrCH ₂	ZrCH ₂ C-(CH ₃) ₃
(31) $[\text{Zr}(\eta\text{-C}_5\text{H}_5)_2(\text{COCH}_2\text{CMe}_3)\text{Cl}]$ ^e	Pale yellow	54.0 (54.0)	6.00 (5.90)	187–189	1 550	4.35	7.15	8.95		
(32) $[\text{Zr}(\eta\text{-C}_5\text{H}_5)_2(\text{COCH}_2\text{SiMe}_3)\text{Cl}]$	White	48.4 (48.4)	5.80 (5.65)	277–279	1 505	4.15	7.05	9.78		
(33) $[\text{Zr}(\eta\text{-C}_5\text{H}_5)_2(\text{COCH}_2\text{CMe}_3)-(\text{CH}_2\text{CMe}_3)]$ ^e	Yellow	64.7 (64.4)	8.00 (8.20)	84–86	1 545	4.45	7.15	8.45	8.52	8.92
(34) $[\text{Zr}(\eta\text{-C}_5\text{H}_5)_2(\text{COCH}_2\text{SiMe}_3)-(\text{CH}_2\text{SiMe}_3)]$ ^e	White	54.0 (53.9)	7.70 (7.55)	73–75	1 500	4.40	7.07	9.40	9.68	9.80
(35) $[\text{Zr}(\eta\text{-C}_5\text{H}_5)_2(\text{COCH}(\text{SiMe}_3)_2)\text{Me}]$	Pale yellow	54.2 (53.9)	7.10 (7.55)	123–125	1 470	4.37	6.22	9.80	9.43	

^a Calculated values are given in parentheses. ^b In a sealed capillary. ^c CH_2Cl_2 solution. ^d At 60 MHz, chemical shifts (signals observed as singlets) (in τ , relative to $\text{SiMe}_4 = \tau$ 10) at ca. 35 °C in C_6H_6 . ^e Carbon-13 n.m.r. (25 MHz) chemical shifts (p.p.m. relative to $\text{SiMe}_4 = 0$) at ca. 35 °C; (31) (CDCl_3) 318.7 (CO), 109.3 (C_5H_5), 60.5 (CO), 31.4 (COCH_2C), 29.6 [$\text{COCH}_2\text{C}(\text{CH}_3)_2$]; (33) (C_6D_6) 322.9 (CO), 107 (C_5H_5), 61.7 (ZrCH₂), 49.0 (CO), 37.5 (ZrCH₂C), 36.8 [$\text{ZrCH}_2\text{C}(\text{CH}_3)_2$], 31.6 (COCH_2C), 30.5 [$\text{COCH}_2\text{C}(\text{CH}_3)_2$]; (34) (C_6D_6) 317.2 (CO), 107.1 (C_5H_5), 43.8 (ZrCH₂), 18.6 (CO), 5.0 [$\text{ZrCH}_2\text{Si}(\text{CH}_3)_2$], 0.17 [$\text{COCH}_2\text{Si}(\text{CH}_3)_2$].

TABLE 4

Nuclear magnetic resonance spectroscopic data on metallocene(IV) halogeno-alkyls and dialkyls

Complex	Solvent	Chemical shift (τ) ^a			Other n.m.r. data ^b
		C ₅ H ₅	CH ₂	CH ₃	
(1)	C ₆ D ₆	4.03	7.15	9.71	$\delta(^{119}\text{Sn}) + 14 \pm 1$ p.p.m.; $^2J(^{119}\text{Sn}^1\text{H})$ 52.3 Hz
	CDCl ₃	3.72	7.02	9.88	
(2)	C ₆ H ₆	4.05	7.86	9.93	
	CDCl ₃	3.67	7.78	9.99	
(3)	C ₆ H ₆	4.01	7.59	9.75	
	CDCl ₃	3.69	7.56	9.86	
(4)	C ₆ D ₆	3.98	7.31	9.78	
	CDCl ₃	3.65	7.16	9.89	
(5)	C ₆ H ₆	4.05	7.95	9.97	
	CDCl ₃	3.58	7.88	9.91	
(6)	C ₆ H ₆	3.93	7.72	9.87	
	CDCl ₃	3.54	7.48	9.82	
[Ti(η -C ₅ H ₅) ₂ (CH ₂ CMe ₃)Cl] ^c	C ₆ H ₆	3.93	7.84	8.92	
	CDCl ₃	3.74	7.89	9.02	
[Ti(η -C ₅ H ₅) ₂ (CH ₃)Cl] ^d	C ₆ H ₆	4.12		9.05	
	CDCl ₃	3.73		9.80	
(7)	C ₆ H ₆	4.04	8.48	9.65	$\delta(^{119}\text{Sn}) + 15 \pm 1$ p.p.m.; $^2J(^{119}\text{Sn}^1\text{H})$ 50.9 Hz
	CDCl ₃	3.73	8.48	9.80	
(8)	C ₆ H ₆	4.04	8.57	9.70	
	CDCl ₃	3.77	8.62	9.87	
[Zr(η -C ₅ H ₅) ₂ (CH ₂ SiMe ₃)Cl] ^e	C ₆ H ₆	3.99	8.98	9.74	
	CDCl ₃	3.67	9.00	9.86	
(9)	C ₆ H ₆	4.00	9.06	9.79	
	CDCl ₃	3.70	9.14	9.93	
(10)	C ₆ H ₆	4.13	8.98	9.65	$\delta(^{119}\text{Sn}) + 16.5 \pm 2$ p.p.m.; $^2J(^{119}\text{Sn}^1\text{H})$ 50.8 Hz
	CDCl ₃	3.83	9.04	9.86	
(11)	C ₆ H ₆	4.06	9.43	9.77	
	CDCl ₃	3.79	9.43	9.92	
(12)	C ₆ H ₆	4.12	9.09	9.68	
	CDCl ₃	3.79	9.12	9.85	
(13)	C ₆ H ₆	4.08	9.54	9.76	
	CDCl ₃	3.74	9.62	9.89	
(14)	C ₆ H ₆	3.98	5.58	9.81	
	CDCl ₃	3.74	5.49	9.96	
(15)	C ₆ H ₆	4.12	8.36	9.79	¹³ C n.m.r.: 112.6 (C ₅ H ₅), 61.6 (CH ₂), -6.0 (CH ₃)
	CDCl ₃	3.98	8.46	9.95	
(16)	C ₆ H ₆	4.10	8.45	9.78 ^f	$\delta(^{119}\text{Sn}) + 4 \pm 2$ p.p.m.; $J(^{119}\text{Sn}^1\text{H})$ 50.0 Hz; ¹³ C n.m.r.: 112.4 (C ₅ H ₅), 62.9 and 62.6 (CH ₂), 3.4 (SiCH ₃), -6.0 (SnCH ₃)
	CDCl ₃	3.92	8.51	9.84 ^g	
(17)	C ₆ H ₆	4.05	8.35	9.77 ^f	
	CDCl ₃	3.86	8.79	10.02 ^g	
(18)	C ₆ H ₆	4.10	8.43	9.77 ^h	
	CDCl ₃	3.96	8.46	9.97 ^f	
(19)	C ₆ H ₆	4.18	8.26	9.80 ^f	
	CDCl ₃	3.96	8.35	9.91 ^f	
(20)	C ₆ H ₆	4.10	8.96	9.84 ^g	
	CDCl ₃	3.90	8.77	9.72 ^j	
(21)	C ₆ H ₆	4.09	8.88	9.91 ^j	
	CDCl ₃	3.96	8.51	10.00 ^f	
(22)	C ₆ H ₆	4.07	9.37	9.70 ^f	¹³ C n.m.r.: 110.1 (C ₅ H ₅), 38.3 (CH ₂), -6.1 (CH ₃); $^1J(^{13}\text{C}^1\text{H})$: 172.1 (C ₅ H ₅), 127.0 (CH ₂), and 114.7 (CH ₃)
	CDCl ₃	3.89	9.49	9.76 ^g	
(23)	C ₆ H ₆ ^k	4.08	9.89	9.89 ^f	
	C ₆ H ₆ ^l	4.05		9.97 ^g	
(24)	C ₆ H ₆ ^m	4.07		9.88,	
	C ₆ H ₆ ⁿ	4.20	9.97	9.73 (Si)	
(25)	C ₆ H ₆ ^o	4.07		9.75 (Si) ⁱ	
	C ₆ H ₆ ^p	4.20		9.70 (Si) ^m	
(26)	C ₆ H ₆ ^q	4.20		9.90	
	[CH(SiMe ₃) ₂]	4.20	<i>o</i>	9.95	
(27)	C ₆ D ₅ CD ₃	3.75	<i>p</i>	(SiMe ₃)	
	CDCl ₃	3.75	<i>p</i>	9.95	
(28)	C ₆ D ₆	4.00	9.28	(SiMe ₃)	
	C ₆ D ₆	4.00	9.28	8.88	

TABLE 4 (continued)

Complex	Solvent	Chemical shift (τ) ^a			Other n.m.r. data ^b
		C ₅ H ₅	CH ₂	CH ₃	
(29)	C ₆ H ₆	4.17	9.66	9.70	¹³ C n.m.r.: 109.6 (C ₅ H ₅), 41.5 (CH ₂), -5.9 (CH ₃); ¹ J(¹³ C ¹ H): 172.1 (C ₅ H ₅), 128.0 (CH ₂), 113.5 (CH ₃)
	CDCl ₃	4.01	9.79	9.89	
(30)	C ₆ H ₆	4.11	9.73	9.69 ^f	
			10.11	9.73 ^g	
	CDCl ₃	3.86	9.72	9.78 ^f	
			10.15	9.84 ^g	

^a Integrated proton ratios correct. ^b ¹¹⁹Sn n.m.r. data from saturated solutions in C₆H₆ [relative to SnMe₄ = 0 (a positive sign indicates a shift to low field of SnMe₄) and for SnMe₄ ¹J(¹¹⁹Sn¹H) = 53.9 Hz] by heteronuclear decoupling of ¹H spectra at 60 MHz, cf. D. H. Harris, M. F. Lappert, W. McFarlane, and J. S. Poland, *J. Chem. Soc., Dalton Trans.*, 1975, 311; ¹³C n.m.r. data at 25 MHz in C₆D₆ in p.p.m. relative to SiMe₄ = 0 at ca. 35 °C. ^c J. A. Waters and G. A. Mortimer, *J. Organomet. Chem.*, 1970, **22**, 417, cite τ 3.48, 7.69, and 9.09 in CDCl₃. ^d J. A. Waters and G. A. Mortimer (see footnote c) cite τ 3.66 and 9.28 in CDCl₃. ^e cf. ref. 16 τ 4.04, 8.97, and 9.78 in C₆H₆. ^f (CH₂SnMe₃). ^g (CH₂SiMe₃). ^h (CH₂CMe₃). ⁱ (CH₂GeMe₃). ^j (CH₃). ^k ZrCH(SiMe₃)₂, 8.2. ^l Also singlet and multiplet in range τ 8.4—9.1. ^m Also singlet and multiplet between τ 8.3 and 9.0. ⁿ Also 8.78 (ZrCH), 9.94 [CH₂C(CH₃)₃]. ^o Also 8.60 (ZrCH), 2.95 (C₅H₅). ^p Also 8.48 (ZrCH), 2.90 (C₅H₅).

C-Sn fission was observed for reactions of the iodide with Na[Mn(CO)₅] or Na[Co(CO)₄].⁸ By contrast, analogous Na[M(η -C₅H₅)(CO)₃] + SnMe₃(CH₂I) \rightarrow [M(η -C₅H₅)Me(CO)₃] + [M(η -C₅H₅)(CO)₃(SnMe₃)] (4)

reactions with SiMe₃(CH₂I) gave the expected trimethylsilylmethyl-metal derivatives.^{7,9}

Thus, one difference between the ⁻CH₂SnMe₃ ligand and its carbon, silicon, or germanium analogues lies in the relative strength of the CH₂-M' bond. For this

would have been more appropriate for a comparison with the thermochemistry, because the silicon derivative (M' = Si) has m.p. 10—11 °C,² and the neopentyl complex forms small, irregular, photosensitive crystals.

RESULTS AND DISCUSSION

New metallocene(IV) chloro-alkyls (1)—(12) are listed in Table 1. They were prepared by one or more of the reactions described by equations (5)—(8).

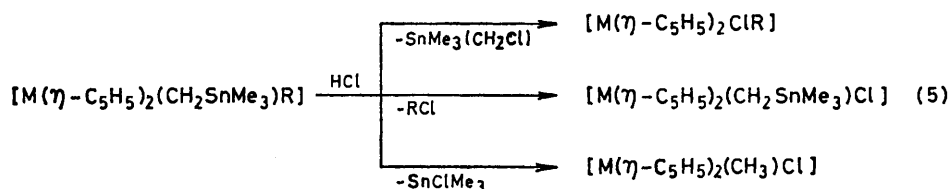

reason, we considered it to be of interest to examine reactions of neopentyl-type alkyls with hydrogen chloride, in that various alternative pathways were possible; additionally, with a mixed dialkyl, relative tendencies for M-C cleavage might be revealed, as for example in equation (5).

Another type of competition experiment reported below, refers again [cf., equation (5)] to a mixed dialkyl as substrate, but now with reference to insertion of CO; the result, on [Zr(η -C₅H₅)₂{CH(SiMe₃)₂}Me], has been mentioned in a preliminary publication.¹⁰

Although the isoleptic ligands ⁻CH₂M'Me₃ (M' = C or Si) have now been used extensively in transition-metal chemistry, the only previous comparative study relates to estimates of M-C bond strengths for the complexes [M(CH₂M'Me₃)₄] (M = Ti, Zr, or Hf).¹¹ Thus, we found (by calorimetry, and hence from the standard heats of formation of these tetra-alkyls) that the mean thermochemical bond-energy term $\bar{E}(\text{M}-\text{CH}_2\text{M}'\text{Me}_3)$ is appreciably smaller for M' = C than M' = Si. The present X-ray study of the complexes [Zr(η -C₅H₅)₂(CH₂M'Me₃)₂] was undertaken to ascertain whether the difference in bond strengths was reflected also in bond lengths; a preliminary communication refers to this point,¹² but without details of their structures. It was impracticable to examine the compounds [Zr(CH₂M'Me₃)₄], which

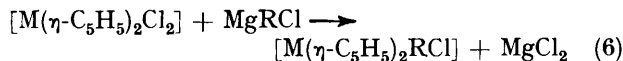

- (1), M = Ti, R = CH₂SnMe₃, 75%
 (2), M = Ti, R = CH₂SiMe₃, 85%
 (7), M = Zr, R = CH₂SnMe₃, 68%
 (10), M = Hf, R = CH₂SnMe₃, 66%
 (11), M = Hf, R = CH₂SiMe₃, 71%

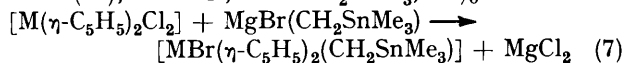

- (4), M = Ti, 72%
 (8), M = Zr, 66%
 (12), M = Hf, 74%

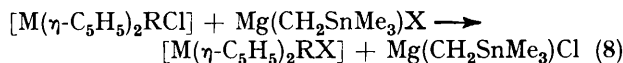

- (5), M = Ti, R = CH₂SiMe₃, X = Br
 (6), M = Ti, R = CH₂SnMe₃, X = I
 (12), M = Hf, R = CH₂SnMe₃, X = Br, 50%

Exchange of M-Cl for M-Br by alkylmagnesium bromides [equation (7)] has been noticed by other workers in the preparations of related compounds, e.g. for [Ti(η -C₅H₅)₂MeX] (X = Br or I).¹³ Similarly, an attempted preparation of [Ti(η -C₅H₅)₂(C₆F₅)₂] from titanocene dichloride and MgBr(C₆F₅) led to a mixture of the dialkyl and the mono-alkylated products [Ti(η -C₅H₅)₂(C₆F₅)₂X] (X = Cl or Br).¹⁴

In the present study, it was found that using a 5–10% excess of alkylmagnesium bromide over that of equation (7) gave the bromo-alkyl product without any appreciable contamination by the chloro-analogue. The driving force for this reaction, and that of equation (8), is presumably connected with the class a ('hard') character of Mg^{2+} . Reactions according to equations (6) and (7) in dichloromethane are slow. Hence, even with a 10% excess over a 1:1 stoichiometry of Grignard reagent, negligible dialkylation occurs and reaction periods less than those quoted in the experimental section of this work resulted in much unconverted starting material. Choice of solvent may also help to cause mono-alkylation [dialkylation by Grignards is effected by a $\geq 2:1$ stoichiometry (Mg : M), in diethyl ether]. Metallocene dichlorides are soluble in CH_2Cl_2 , but virtually insoluble in OEt_2 . Consequently, for the rates of addition employed, the Grignard reagent is always in excess in solution during dialkylation, whereas the metallocene dichloride is in excess during mono-alkylation.

It is more difficult to introduce the ligand $^-CH_2SnMe_3$ onto a Group 4 transition metal than it is to introduce the silicon analogue under the same conditions by means of reactions (6) or (7). This is reflected in the longer reaction times and a greater excess of Grignard required for the tin-containing chloro-alkyls. The ease of forming an $M-CH_2SnMe_3$ bond decreases with M in the order $Ti > Zr > Hf$. This is quite a marked effect and, in so far as evidence is available, seems to be true for other M -alkyl bond-forming processes. An example is that whereas reaction according to equation (6) for $R = CH_2SnMe_3$ proceeded to completion after 6 h for $M = Ti$, a longer period (12 h) was required for $M = Zr$, and for $M = Hf$, starting material was 30% unchanged after 34 h even with a greater excess of Grignard reagent.

Thus it appears that conversion of an $M-Cl$ to an $M-Br$ or $M-I$ complex according to equation (7) is a general and facile reaction. A satisfactory alternative

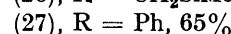
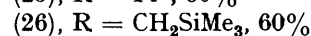
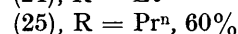
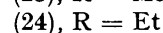
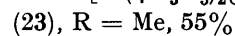
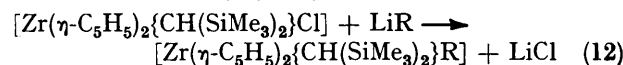
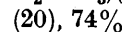
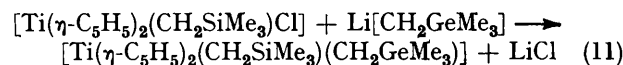
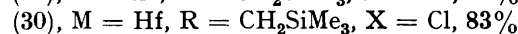
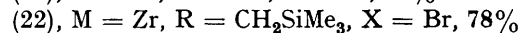
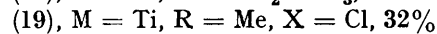
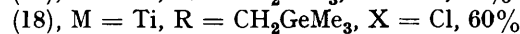
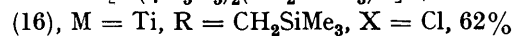
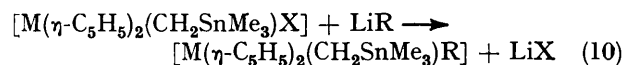
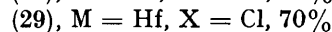
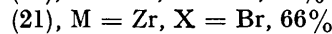
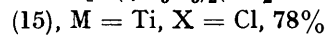
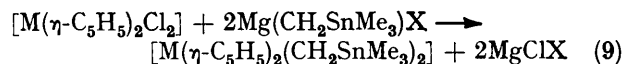

by the relative ease of dialkylation [equation (9)] and halogen exchange [equation (7)] for the case of $[Ti(\eta-C_5H_5)_2(CH_2M'SiMe_3)Cl]$ as substrate and $MgBr(CH_2-SnMe_3)$ as reagent in OEt_2 after 30 min at 20 °C: with $M' = Sn$ the product of the latter process was formed exclusively, whereas with $M' = Si$ it was obtained in 10% yield, the dominant product (90%) being the dialkyl.

With regard to the thermal stability of the dialkyls (15)–(22), (29), and (30), the neopentyl complexes are noticeably less robust than the $^-CH_2M'Me_3$ ($M' = Si, Ge, \text{ or } Sn$) analogues; similarly, $[Ti(\eta-C_5H_5)_2(CH_2SnMe_3)_2]$ is the most photolabile of the complexes $[M(\eta-C_5H_5)_2-(CH_2SnMe_3)R]$.

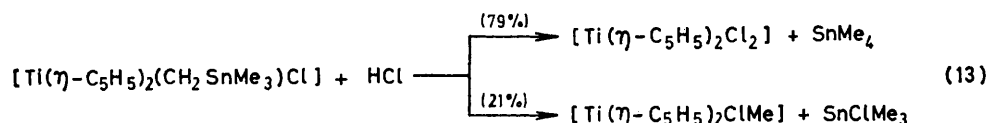

exchange reagent other than $MgBr(CH_2SnMe_3)$ was not found, although an extensive search was not made. Treatment of $[Ti(\eta-C_5H_5)_2(CH_2SnMe_3)Cl]$ with either $LiBr$ or $NaBr$ in diethyl ether resulted in Ti -alkyl cleavage, to form titanocene dibromide, at a rate comparable to halide exchange. Reaction with $NaBr$ in dry methanol increased the rate of consumption of starting material, but the alcohol caused extensive cleavage of both Ti -alkyl and $Ti-C_5H_5$ bonds.¹⁵

The metallocene dialkyls (15)–(30) (Table 2) were prepared according to equations (9)–(12), generally in high yield. A limitation of reactions (10)–(12) is that we have been unable to prepare the reagent $Li[CH_2-SnMe_3]$.³ A further interesting difference between the $^-CH_2SiMe_3$ and $^-CH_2SnMe_3$ ligands is demonstrated

In order to investigate the hydrogen chloride cleavage reactions of equation (5), one mole of HCl in OEt_2 was slowly added to the metallocene(IV) dialkyl (1 mol) in OEt_2 at ca. 20 °C; after 40 min, the volatiles were removed *in vacuo* and the composition of the solid residue and of the volatiles determined by 1H n.m.r. spectroscopy in $CDCl_3$ and C_6H_6 . The proportions of products quoted in Table 5 are based upon integrations of comparable peaks in these spectra, and were confirmed by duplication of spectra and of experiments. Minor amounts of unreacted dialkyl and metallocene dihalide (from cleavage of both alkyl groups) were observed, but the monoalkylated products were predominant.

The cleavage of $[Ti(\eta-C_5H_5)_2(CH_2SnMe_3)Cl]$ is different from the dialkyls, in that it is the only case where signifi-

cant scission of the $\text{CH}_2\text{-Sn}$ bond occurred, equation (13); under these conditions SnMe_4 does not react with HCl . Reaction of the corresponding dialkyl $[\text{Ti}(\eta\text{-C}_5\text{H}_5)_2(\text{CH}_2\text{SnMe}_3)_2]$ gave predominant Ti-C cleavage, and no observable quantities of products arising from Sn-CH_2 scission were found from reactions of mixed dialkyls containing the $\text{-CH}_2\text{SnMe}_3$ ligand.

It was reported¹⁶ that the reaction of less than one equivalent of ethereal HCl with $[\text{Zr}(\eta\text{-C}_5\text{H}_5)_2(\text{CH}_2\text{SiMe}_3)_2]$, at either 20 °C or -78 °C furnishes only zirconocene dichloride and unchanged starting material. It is now found (Table 5) that with a 1 : 1 stoichiometry at 20 °C,

and 110 min respectively. The reactions were monitored by ^1H n.m.r. spectroscopy. The greater lability of titanium(IV) over zirconium(IV) or hafnium(IV) compounds has previously been noted for the series $[\text{M}(\eta\text{-C}_5\text{H}_5)_2(\text{CH}_2\text{Ph})_2]$.¹⁷

The zirconocene(IV) dialkyls $[\text{Zr}(\eta\text{-C}_5\text{H}_5)_2\{\text{CH}(\text{SiMe}_3)_2\text{-R}]$ ($\text{R} = \text{Me, Et, Pr}^n, \text{CH}_2\text{SiMe}_3, \text{ or Ph}$), (23)–(27), were prepared in part in order to determine their conformation. It was shown that there is an exceptionally high barrier to rotation about the Zr-CH bond, ΔG^\ddagger being in the range 45–55 kJ mol^{-1} ,¹² and that the preferred solution conformation is that of the Newman projection (36) rather

TABLE 5

The acid cleavage products of the metallocene(IV) dialkyls $[\text{M}(\eta\text{-C}_5\text{H}_5)_2\text{RR}']$ [cf. equation (5)] *

Reagents			Acid (HX)	Products (%)				No. of mol of R' cleaved per mol of $\text{R} = \text{CH}_2\text{SnMe}_3$ cleaved
M	R	R'		$[\text{M}(\eta\text{-C}_5\text{H}_5)_2\text{XR}]$	$[\text{M}(\eta\text{-C}_5\text{H}_5)_2\text{XR}']$	$[\text{M}(\eta\text{-C}_5\text{H}_5)_2\text{X}_2]$	$[\text{M}(\eta\text{-C}_5\text{H}_5)_2\text{RR}']$	
Ti	CH_2SnMe_3	CH_2SnMe_3	HCl	94	1	4	1	
Ti	CH_2SnMe_3	CH_2SiMe_3	HCl	13	69	18	0.19	
Ti	CH_2SnMe_3	CH_2GeMe_3	HCl	14	76	8	0.18	
Ti	CH_2SnMe_3	CH_2CMe_3	HCl	25	36	39	0.69	
Ti	CH_2SnMe_3	Me	HCl	0	97	0	0.00	
Ti	CH_2SiMe_3	CH_2GeMe_3	HCl	37	45	12		
Zr	CH_2SnMe_3	CH_2SiMe_3	HCl	28	58	9	0.48	
Hf	CH_2SnMe_3	CH_2SiMe_3	HCl	26	59	9	0.44	
Ti	CH_2SnMe_3	CH_2SiMe_3	HBr	12	59	25	0.20	
Zr	CH_2SnMe_3	CH_2SiMe_3	HBr	25	57	11	0.44	
Hf	CH_2SnMe_3	CH_2SiMe_3	HBr	23	57	10	0.40	

* Reaction carried out on equimolar portions of the reagents in diethyl ether at 20 °C.

the monoalkyl $[\text{Zr}(\eta\text{-C}_5\text{H}_5)_2(\text{CH}_2\text{SiMe}_3)\text{Cl}]$ is the preponderant product. The earlier result¹⁶ is probably explained by the inadvertent presence of moisture which readily converts the chloro-alkyl compound into $[\{\text{Zr}(\eta\text{-C}_5\text{H}_5)_2\text{Cl}\}_2\text{O}]$, which has similar spectral and solubility characteristics as $[\text{Zr}(\eta\text{-C}_5\text{H}_5)_2\text{Cl}_2]$.

The comparative abilities of the alkyl ligands as leaving groups in the HCl cleavage of the series $[\text{Ti}(\eta\text{-C}_5\text{H}_5)_2(\text{CH}_2\text{SnMe}_3)\text{R}]$ (Table 5) gives the order $\text{R} = \text{CH}_2\text{SnMe}_3$ (1.0) > CH_2CMe_3 (0.69) > CH_2SiMe_3 (0.19) \geq CH_2GeMe_3 (0.18) > Me (0), where the number in parentheses refers to the mol Ti-R cleavage product per mol of mixed dialkyl. Consistent with the relative position of the $\text{-CH}_2\text{M}'\text{Me}_3$ ($\text{M}' = \text{Si}$ or Ge) ligands, the dialkyl $[\text{Ti}(\eta\text{-C}_5\text{H}_5)_2(\text{CH}_2\text{GeMe}_3)(\text{CH}_2\text{SiMe}_3)]\text{-HCl}$ reaction confirms that $\text{-CH}_2\text{SiMe}_3$ is marginally the better leaving group.

The effect of changing the Group 4 atom, M, in the series $[\text{M}(\eta\text{-C}_5\text{H}_5)_2(\text{CH}_2\text{SnMe}_3)(\text{CH}_2\text{SiMe}_3)]$ on cleavage by either HCl or HBr shows that although the trimethylstannylmethyl group is the better leaving group in all cases, the disparity between the two ligands is less for $\text{M} = \text{Zr}$ (0.48 or 0.44) or Hf (0.44 or 0.40) than for $\text{M} = \text{Ti}$ (0.19 or 0.20); moreover the HCl or HBr results are closely similar.

The effect of heat on the dialkyls $[\text{M}(\eta\text{-C}_5\text{H}_5)_2(\text{CH}_2\text{-SnMe}_3)_2]$ ($\text{M} = \text{Ti, Zr, or Hf}$) and $[\text{M}''(\eta\text{-C}_5\text{H}_5)_2(\text{CH}_2\text{-SiMe}_3)_2]$ ($\text{M}'' = \text{Ti or Zr}$) revealed that only the titanium compounds underwent significant decomposition at 80 °C in toluene solution (10%) to yield SnMe_4 (1.6 mol per mol dialkyl) and SiMe_4 (1.5 mol per mol dialkyl) with $t_{1/2}$ 140

than (37) (inequivalent pairs of SiMe_3 and $\eta\text{-C}_5\text{H}_5$ groups), a result confirmed for the solid state by an X -ray study of the phenyl compound (27).

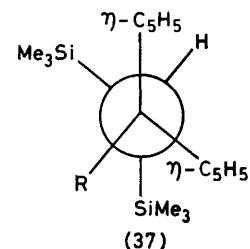
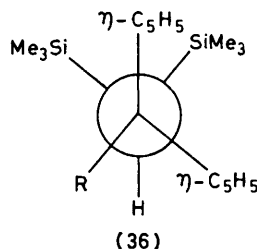

There was no exchange of alkyl ligands when equimolar portions of $[\text{Zr}(\eta\text{-C}_5\text{H}_5)_2(\text{CH}_2\text{SiMe}_3)_2]$ and $[\text{Zr}(\eta\text{-C}_5\text{H}_5)_2(\text{CH}_2\text{CMe}_3)_2]$ were mixed in C_6D_6 and left in an n.m.r. tube for 12 h at 20 °C, or after heating for 0.5 h at 80 °C.

The carbon monoxide insertion reactions are summarised in equation (14) * and the characterisation of the monoacyls is in Table 3. The i.r. and n.m.r. data show

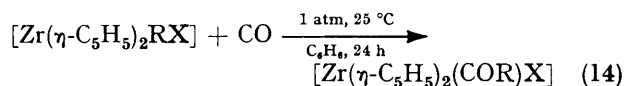

(31), $\text{R} = \text{CH}_2\text{CMe}_3$, $\text{X} = \text{Cl}$, 83%

(32), $\text{R} = \text{CH}_2\text{SiMe}_3$, $\text{X} = \text{Cl}$, 80%

(33), $\text{R} = \text{CH}_2\text{CMe}_3 = \text{X}$, 85%

(34), $\text{R} = \text{CH}_2\text{SiMe}_3 = \text{X}$, yield not recorded

(35), $\text{R} = \text{CH}(\text{SiMe}_3)_2$, $\text{X} = \text{Me}$, 100% crude

* Throughout this paper: 1 atm = 101 325 Pa.

that the acyl compounds (31)—(35) are η^2 -bonded, (38), as had first been established by Floriani and co-workers¹⁸ for $[\text{Zr}(\eta\text{-C}_5\text{H}_5)_2(\text{COMe})\text{Me}]$. The compounds (31)—(35) are stable crystalline compounds which do not dis-

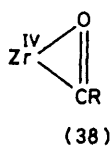

sociate into their factors in solution at 25 °C, in contrast to $[\text{Zr}(\eta\text{-C}_5\text{H}_5)_2(\text{COR})\text{R}]$ (R = Me or CH_2Ph).¹⁸ The ¹³C n.m.r. chemical-shift assignments for C_{acyl} and C_{alkyl} are based on comparison with data on the parent dialkyls (Table 2).

The most interesting carbonylation result is that in which there is, in principle, competition between CO insertion into one of two different Zr-alkyl bonds [equation (14), R = $\text{CH}(\text{SiMe}_3)_2$, X = Me] and it is the more hindered (and weaker) bond which is broken. This may be rationalised by the suggestion that it is the more thermodynamically favoured of the two possible isomeric products which is formed. In the particular case in question, the thermodynamic preference of complex (35) over its isomer $[\text{Zr}(\eta\text{-C}_5\text{H}_5)_2\{\text{CH}(\text{SiMe}_3)_2\}(\text{COMe})]$, is governed by the appreciable *F*-steric strain* in the Zr-CH bond of the latter. An alternative, and probably preferred explanation (suggested to us by Mr. G. S. Bristow), is based on a mechanistic argument, and concerns the structure of the intermediate for CO insertion:¹⁹ there are three possibilities, (39)—(41).

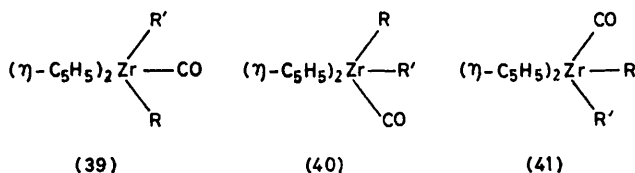

Structures (39) and (40) are less favourable than (41) for the case of R = $\text{CH}(\text{SiMe}_3)_2$ and R' = Me, because in (39) and (40) these are unacceptably close $\eta\text{-C}_5\text{H}_5 \cdots \text{R}$ contacts; and CO co-ordination at a central position between R and R', as in (39), is in any case unlikely.¹⁹ That steric effects are important was demonstrated by the observation that carbon monoxide did not react with $[\text{Zr}(\eta\text{-C}_5\text{H}_5)_2\{\text{CH}(\text{SiMe}_3)_2\}(\text{CH}_2\text{SiMe}_3)]$ under the conditions applicable to the formation of the acyl complexes of equation (14) [for which the formation of complex (35) was significantly the slowest].

It was noted¹⁰ that in a similar fashion to the above carbonylations, *p*-tolyl isonitrile reacts with $[\text{Zr}(\eta\text{-C}_5\text{H}_5)_2\{\text{CH}(\text{SiMe}_3)_2\}\text{Me}]$ to yield exclusively $[\text{Zr}(\eta\text{-C}_5\text{H}_5)_2\{\eta^2\text{-C}(\text{NC}_6\text{H}_4\text{Me-}p)\}[\text{CH}(\text{SiMe}_3)_2]\text{Me}]$ rather than the product of *p*-tolyl isonitrile insertion into the Zr-Me bond.

In the ¹H n.m.r. spectra of compounds containing the trimethylstannylmethyl ligand, the coupling constants ²*J*(¹¹⁹Sn-H) and ²*J*(¹¹⁷Sn-H) have been used, first, to

* See H. C. Brown, *J. Chem. Soc.*, 1956, 1248.

verify that a Sn-C-H unit is present and secondly, to differentiate between an Sn-CH₂- and an Sn-CH₃ situation. In all such compounds, these coupling constants were in the range 71—76 Hz (¹¹⁹Sn-CH₂) and 49—51 Hz (¹¹⁹Sn-CH₃) or 68—73 Hz (¹¹⁷Sn-CH₂) and 47—48 Hz (¹¹⁷Sn-CH₃) and were not altered by change of solvent from benzene, deuteriobenzene, or deuteriochloroform.

Molecular Structures of the Complexes $[\text{Zr}(\eta\text{-C}_5\text{H}_5)_2(\text{CH}_2\text{M}'\text{Me}_3)_2]$ [M' = C (28) or Si (42)].—Suitable crystals of compounds (28) and (42)¹⁶ were obtained by low-temperature recrystallisation from *n*-C₅H₁₂.

The molecular structure and atom-numbering scheme for dicyclopentadienylbis(trimethylsilylmethyl)zirconium(IV), (42), is shown in Figure 1. Since there are four

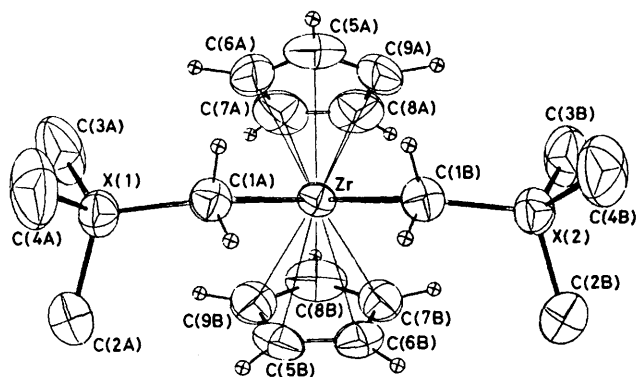

FIGURE 1 Molecular structure and atom-numbering scheme for $[\text{Zr}(\eta\text{-C}_5\text{H}_5)_2(\text{CH}_2\text{SiMe}_3)_2]$, (42) (X = Si), with the atoms represented by their 50% probability ellipsoids for thermal motion

molecules per unit cell in the space group $P2_1/c$, no crystallographically imposed symmetry exists and there are two independent determinations of the Zr-C(σ) bond length. These values, 2.278(4) and 2.281(4) Å, are not significantly different from each other nor from that found in $[\text{Zr}(\eta\text{-C}_5\text{H}_5)_2\text{Me}_2]$, 2.283(6) Å.²⁰ They may therefore be regarded as normal Zr-C(σ) bonds without undue influence from steric factors. The Zr-C(η^5 -) lengths average 2.52 Å, in close agreement with the 2.51 Å norm for compounds of this type.

Figure 2 presents the molecular structure of dicyclo-

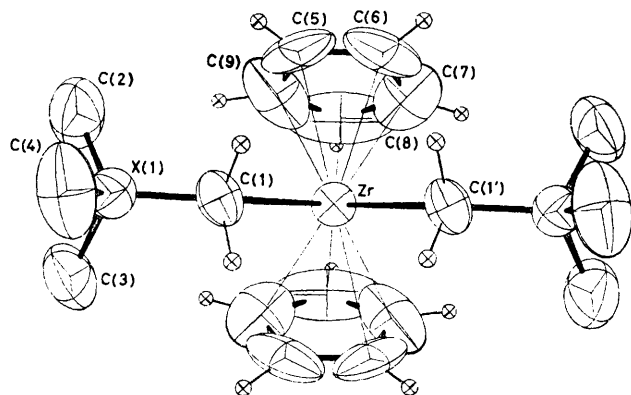

FIGURE 2 Molecular structure and atom-numbering scheme for $[\text{Zr}(\eta\text{-C}_5\text{H}_5)_2(\text{CH}_2\text{CMe}_3)_2]$, (28) (X = C)

pentadienyldi(neopentyl)zirconium(IV), (28). The X-ray data set was of somewhat lower quality than that for the silicon analogue (42) because of intrinsic problems of crystallinity. The bond distances and angles are thus not as accurate as those for the trimethylsilylmethyl derivative. In addition, the neopentyl complex (28) belongs to the tetragonal space group *I4* with four molecules per unit cell. The molecule itself contains a crystallographic two-fold axis and yields only one determination of the Zr-C(σ) bond length and five evaluations of the Zr-C(η^5 -) distance.

TABLE 6

Bond lengths (Å) and angles (°) for $[\text{Zr}(\eta\text{-C}_5\text{H}_5)_2(\text{CH}_2\text{M}'\text{Me}_3)_2]$ [$\text{M}' = \text{Si}$ (42) or C (28)] with estimated standard deviations in parentheses *

	$\text{M}' = \text{Si}$		$\text{M}' = \text{C}$
	Ring A	Ring B	
Zr-C(1)	2.278(4)	2.281(4)	2.294(8)
Zr-C(5)	2.556(6)	2.541(4)	2.50(2)
Zr-C(6)	2.544(5)	2.538(5)	2.52(3)
Zr-C(7)	2.498(7)	2.505(4)	2.52(3)
Zr-C(8)	2.492(6)	2.508(4)	2.52(3)
Zr-C(9)	2.535(4)	2.512(5)	2.47(3)
Average	2.53(3)	2.52(2)	2.51(2)
Zr-Cent	2.24	2.23	2.25
C(5)-C(6)	1.386(9)	1.377(7)	1.33(3)
C(6)-C(7)	1.376(11)	1.381(7)	1.31(4)
C(7)-C(8)	1.370(9)	1.389(8)	1.34(5)
C(8)-C(9)	1.372(10)	1.393(7)	1.33(5)
C(9)-C(5)	1.374(9)	1.389(7)	1.31(4)
C(9)-C(5)-C(6)	107.5(6)	108.4(4)	107(2)
C(5)-C(6)-C(7)	108.2(5)	108.7(4)	110(2)
C(6)-C(7)-C(8)	107.6(6)	107.3(4)	107(2)
C(7)-C(8)-C(9)	108.8(6)	108.5(4)	108(2)
C(8)-C(9)-C(5)	108.0(5)	107.0(4)	109(2)
	Ligand A	Ligand B	
C(1)-X	1.847(4)	1.845(4)	1.52(1)
X-C(2)	1.861(5)	1.851(6)	1.52(2)
X-C(3)	1.836(7)	1.872(6)	1.54(2)
X-C(4)	1.865(7)	1.862(6)	1.54(1)
C(1)-H(1)	0.95	0.91	1.04
C(1)-H(2)	0.98	1.03	1.01
Zr-C(1)-X	135.2(2)	133.8(2)	142.7(5)
Zr-C(1)-H(1)	97	99	100
Zr-C(1)-H(2)	100	97	101
X-C(1)-H(1)	109	109	101
X-C(1)-H(2)	107	112	103
H(1)-C(1)-H(2)	106	102	106
C(1)-X-C(2)	113.1(2)	112.6(2)	112.3(9)
C(1)-X-C(3)	113.7(2)	113.4(2)	111.5(9)
C(1)-X-C(4)	110.1(2)	110.6(2)	108.6(8)
C(2)-X-C(3)	107.3(3)	106.5(3)	104.1(10)
C(2)-X-C(4)	105.1(3)	107.1(3)	111.7(10)
C(3)-X-C(4)	107.0(3)	106.2(3)	108.6(10)
Cent(1)-Zr-Cent(2)	129.9		128.3
C(1A)-Zr-C(1B)	97.8(1)		89.9(4)
Cent(1)-Zr-C(1A)	106.4		108.9
Cent(1)-Zr-C(1B)	105.6		107.0
Cent(2)-Zr-C(1A)	106.5		
Cent(2)-Zr-C(1B)	106.0		

* Cent = Centroid of C_5H_5 ring.

From the comparison of bond lengths and angles given in Table 6 it is apparent that the expected large difference in Zr-C(σ) bond lengths has not been realised. Although that of the neopentyl derivative is slightly larger, this

cannot be viewed as significant because of the estimated standard deviations (e.s.d.s) involved.

A difference can be found in the Zr-C(η^5 -) bond lengths, by a careful scrutiny of Table 6. The observed values indicate that those for $[\text{Zr}(\eta\text{-C}_5\text{H}_5)_2(\text{CH}_2\text{CMe}_3)_2]$ are shorter, 2.51(2) Å, than those for $[\text{Zr}(\eta\text{-C}_5\text{H}_5)_2(\text{CH}_2\text{SiMe}_3)_2]$, 2.52(2) Å. However, this is an artifact due to the thermal motion of the cyclopentadienyl ring. The effect, which has been described in detail by Bernal and co-workers,²¹ is most noticeable in the C-C bond lengths. In the absence of a librational motion of the ring these lengths should be near 1.43 Å.²² Both structures show evidence of the effect, but it is most obvious for the neopentyl complex (average C-C = 1.32 Å compared to 1.38 Å in the trimethylsilylmethyl derivative). Ramifications can also be seen in the Zr-C bond lengths: with high libration the pentagons appear smaller, and the Zr-C distances seem shorter than they are in reality. The parameter which is *not* subject to these considerations is the zirconium-centroid separation. For $[\text{Zr}(\eta\text{-C}_5\text{H}_5)_2(\text{CH}_2\text{CMe}_3)_2]$ this is 2.25 Å, while for $[\text{Zr}(\eta\text{-C}_5\text{H}_5)_2(\text{CH}_2\text{SiMe}_3)_2]$ the two values are 2.23 and 2.24 Å. As a comparison, the zirconium-centroid lengths can be converted to Zr-C(η^5 -) bond distances for an idealised cyclopentadienyl ring: $D(\text{Zr-C})^2 = D(\text{Zr-centroid})^2 + (1.21)^2$, where 1.21 Å is the distance from carbon atoms to the centroid of the ring with the C-C assumed to be 1.43 Å. The calculation yields 2.555 and 2.541 Å for the neopentyl and trimethylsilylmethyl structures respectively. The placement of the five-membered ring 0.014 Å further from the zirconium atom can be viewed as roughly equivalent to the elongation of *ca.* 0.07 Å of a single metal-carbon bond.

In conclusion, the larger steric requirement of the neopentyl ligand has been found to manifest itself in a slightly larger Zr-C(σ) bond, and a greater Zr-cyclopentadienyl approach. The exact manner in which this relates to the thermochemical data is not obvious, but the effects do run in the same direction. Further

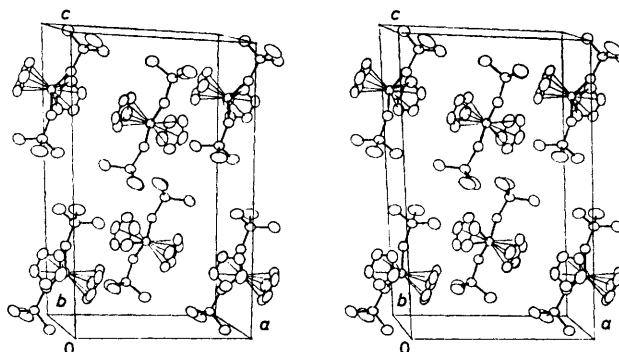

FIGURE 3 Stereoscopic view of the unit-cell packing for $[\text{Zr}(\eta\text{-C}_5\text{H}_5)_2(\text{CH}_2\text{SiMe}_3)_2]$, (42)

comparisons of X-ray crystal-structure data with thermochemical bond-strength evaluations are planned with this series of compounds.

The cyclopentadienyl rings are planar to within 0.01 Å

for the silicon complex, and 0.02 Å for the neopentyl analogue (28). Stereoscopic views of the unit-cell contents are presented in Figures 3 and 4. No unusual

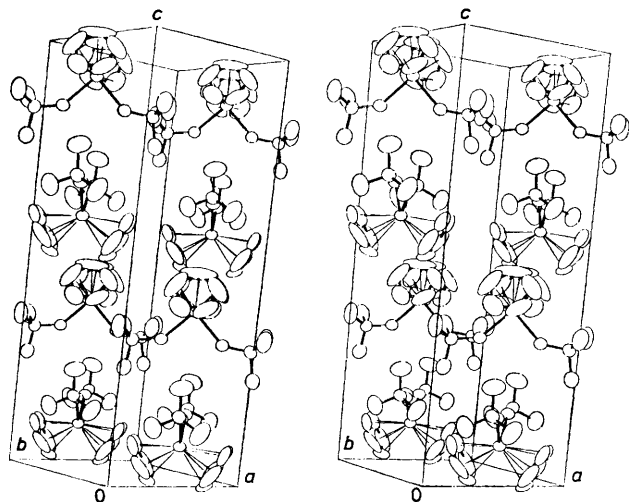

FIGURE 4 Stereoscopic view of the unit-cell packing for $[\text{Zr}(\eta\text{-C}_5\text{H}_5)_2(\text{CH}_2\text{CMe}_3)_2]$, (28)

contacts are noted. In Table 7 are shown the least-squares plane calculations.

TABLE 7

Least-squares plane calculations for $[\text{Zr}(\eta\text{-C}_5\text{H}_5)_2(\text{CH}_2\text{M}'\text{Me}_3)_2]$ [$\text{M}' = \text{Si}$ (42) or C (28)]

Plane defined by C(5), C(6), C(7), C(8), and C(9)

$$\begin{aligned} \text{M}' = \text{Si} \quad & \begin{cases} \text{(A)} & 0.9046X - 0.2772Y - 0.3237Z = -0.2849 \\ \text{(B)} & 0.7443X + 0.6033Y - 0.2864Z = -3.3256 \end{cases} \\ \text{M}' = \text{C} \quad & 0.6366X + 0.6298Y - 0.4450Z = -4.1463 \end{aligned}$$

Deviations:

	$\text{M}' = \text{Si}$		$\text{M}' = \text{C}$
C(5)	-0.006	-0.003	0.004
C(6)	0.006	-0.005	-0.018
C(7)	-0.004	0.011	0.024
C(8)	0.001	-0.013	-0.021
C(9)	0.003	0.010	0.011
Zr	2.24	2.23	2.25

The present X-ray results may be compared with those on others of general formula $[\text{Zr}(\eta\text{-C}_5\text{H}_5)_2\text{R}_2]$ ²⁰ and $[\text{Zr}(\eta\text{-C}_5\text{H}_4\text{R}')\text{RCl}]$.¹ For $\text{R} = \text{alkyl}$, Zr-C(alkyl) distances range from 2.251(6) Å in $[\text{Zr}(\eta\text{-indenyl})_2\text{Me}_2]$ ²³ to 2.388(12) Å in $[\text{Zr}(\eta\text{-C}_5\text{H}_5)_2(\text{CHPh}_2)_2]$; ²⁴ another rather long Zr-C_{sp^2} bond is in $[\text{Zr}(\eta\text{-C}_5\text{H}_5)_2\{\text{CH}(\text{SiMe}_3)_2\}\text{Ph}]$, 2.388(12) Å.¹² For unsubstituted C_5H_5^- ligands the $\text{Zr-C}(\eta^5)$ lengths show extreme values of 2.48(2) Å in $[\text{Zr}(\eta\text{-C}_5\text{H}_5)_2\text{I}_2]$ ²⁵ and 2.58(3) Å in $[\text{Zr}(\text{C}_5\text{H}_5)_4]$,²⁶ but cluster around 2.51 Å.²³

EXPERIMENTAL

General procedures have been discussed in earlier Parts.¹ The trimethylstannylmethyl-Grignard reagents were prepared essentially as described⁶ for $\text{Mg}(\text{CH}_2\text{SnMe}_3)\text{Cl}$.

Synthesis of Metallocene(IV) Halogeno-alkyls, (1)–(13).—Only selected examples are described here; further details are in Tables 1 and 4, and in ref. 3.

(a) $[\text{Ti}(\eta\text{-C}_5\text{H}_5)_2(\text{CH}_2\text{SnMe}_3)\text{Cl}]$. A solution of $\text{Mg}(\text{CH}_2\text{-SnMe}_3)\text{Cl}$ (0.269 mol dm^{-3} , 7.67 mmol) in diethyl ether (28.5 cm^3) was added during 30 min to a stirred solution of dichlorobis(η -cyclopentadienyl)titanium(IV) (1.82 g, 7.30 mmol) in dichloromethane (ca. 120 cm^3) at 20 °C. During addition, the red solution deepened in colour. After stirring at room temperature for 6 h, the solvents were removed *in vacuo* and the orange residue extracted with benzene (ca. 70 cm^3) and filtered, to form an intense red solution. This solution was concentrated to ca. 30 cm^3 , hexane (30 cm^3) was added, and cooled to -20 °C. The crystals so formed were filtered off and washed with a little cold hexane, then dried *in vacuo* to give shiny orange crystals of the product (2.14 g, 75%).

(b) $[\text{ZrBr}(\eta\text{-C}_5\text{H}_5)_2(\text{CH}_2\text{SnMe}_3)]$. A solution of trimethylstannylmethylmagnesium bromide (0.163 mol dm^{-3} , 3.15 mmol) in diethyl ether (19.3 cm^3) was added during 20 min to a stirred solution of dichlorobis(η -cyclopentadienyl)-zirconium(IV) (0.877 g, 3.00 mmol) in dichloromethane (70 cm^3) at 20 °C. The solution became lemon-yellow during addition. The mixture was stirred at room temperature for 28 h, the solvents removed *in vacuo*, and the yellow residue extracted with benzene (10 cm^3) and filtered. The filtrate was concentrated to ca. 6 cm^3 , hexane (6 cm^3) added, and cooled to -20 °C. The resulting crystals were filtered off while cold, washed with a little cold hexane, and dried *in vacuo* to give very pale yellow, shiny crystals of the product (0.958 g, 66%).

(c) $[\text{Hf}(\eta\text{-C}_5\text{H}_5)_2(\text{CH}_2\text{SnMe}_3)\text{Cl}]$. A solution of trimethylstannylmethylmagnesium chloride (0.275 mol dm^{-3} , 5.50 mmol) in diethyl ether (20.0 cm^3) was added during 30 min to a stirred solution of dichlorobis(η -cyclopentadienyl)-hafnium(IV) (1.90 g, 5.00 mmol) in dichloromethane (80 cm^3) at 20 °C. During addition, the colourless solution became pale yellow, and was stirred at ca. 20 °C for 34 h, solvents removed *in vacuo*, and the yellow residue extracted with benzene (30 cm^3) and filtered. To the very pale yellow filtrate hexane (15 cm^3) was added, and the solution cooled to -20 °C; filtration gave white crystals of the starting material, dichlorobis(η -cyclopentadienyl)hafnium(IV) (0.580 g, 30.5%), identified by n.m.r. The filtrate was reduced in volume to ca. 10 cm^3 , hexane (10 cm^3) added and cooled to -20 °C. The resulting crystals were filtered off while cold, washed with a little cold hexane, and dried *in vacuo* to give white crystals of the product (1.20 g, 66%, based on dichloride consumed).

(d) $[\text{Ti}(\eta\text{-C}_5\text{H}_5)_2(\text{CH}_2\text{SiMe}_3)\text{Cl}]$. A solution of trimethylsilylmethylmagnesium chloride (0.250 mol dm^{-3} , 10.5 mmol) in diethyl ether (42.0 cm^3) was added during 30 min to a stirred solution of dichlorobis(η -cyclopentadienyl)titanium(IV) (2.49 g, 10.0 mmol) in dichloromethane (150 cm^3) at 20 °C. The red solution deepened in colour during addition. After stirring for 2 h at room temperature, solvents were removed *in vacuo*, and the red residue extracted with benzene (50 cm^3) and filtered. The filtrate was concentrated to ca. 20 cm^3 , hexane (20 cm^3) added, and cooled to -20 °C. The resulting crystals were filtered off while cold, washed with a little cold hexane, and dried *in vacuo* to give orange-red crystals of the product (2.57 g, 85%).

Exchange Reactions.—(a) *Synthesis of* $[\text{HfBr}(\eta\text{-C}_5\text{H}_5)_2(\text{CH}_2\text{-SiMe}_3)]$. A solution of trimethylstannylmethylmagnesium bromide (0.163 mol dm^{-3} , 0.084 2 mmol) in diethyl ether (0.52 cm^3) was added during 5 min to a stirred solution of chlorobis(η -cyclopentadienyl)trimethylsilylmethylhafnium(IV) (0.030 3 g, 0.070 2 mmol) in diethyl ether (5 cm^3) at

20 °C. After stirring for 20 min, the solvents were removed *in vacuo*. Recrystallisation from hexane yielded white crystals of the *product* (0.017 g, 50%).

(b) *Synthesis of* $[\text{Ti}(\eta\text{-C}_5\text{H}_5)_2(\text{CH}_2\text{SnMe}_3)\text{I}]$. A solution of trimethylstannylmethylmagnesium iodide (0.089 mol dm⁻³, 1.43 mmol) in diethyl ether (16.1 cm³) was added during 5 min to a stirred solution of chlorobis(η -cyclopentadienyl)-(trimethylstannylmethyl)titanium(IV) (0.510 g, 1.30 mmol) in diethyl ether (50 cm³) at 20 °C. After stirring for 25 min, the solvent was removed *in vacuo*. The dark red residue was extracted with benzene (15 cm³) and filtered. The deep red filtrate was concentrated to *ca.* 10 cm³, hexane (5 cm³) added and cooled to -20 °C. From this solution di-iodine crystallised out. Repeated recrystallisation of the filtrate produced red crystals of the *product*, but it was contaminated with di-iodine, and a satisfactory micro-analysis was not obtained; characterisation was by n.m.r. (Table 1).

(c) *Attempted synthesis of* $[\text{TiBr}(\eta\text{-C}_5\text{H}_5)_2(\text{CH}_2\text{SnMe}_3)]$. A solution of trimethylstannylmethylmagnesium bromide (0.163 mol dm⁻³, 0.216 mmol) in diethyl ether (1.33 cm³) was added during 5 min to a stirred solution of chlorobis(η -cyclopentadienyl)-(trimethylsilylmethyl)titanium(IV) (0.059 g, 0.196 mmol) in dichloromethane (10 cm³) at 20 °C. After stirring for 5 min, the solvents were removed *in vacuo*, and an n.m.r. spectrum of the residue run. This showed the presence of the starting material, the *product*, and $[\text{Ti}(\eta\text{-C}_5\text{H}_5)_2(\text{CH}_2\text{SnMe}_3)_2]$, (15), in an approximate 2 : 1 : 1 ratio. In a similar reaction, using only diethyl ether as the solvent, and a reaction time of 30 min, the dialkyl (15) was the sole product.

(d) *The reaction of chlorobis(η -cyclopentadienyl)-(trimethylstannylmethyl)titanium(IV) with anhydrous sodium bromide in diethyl ether.* A solution of chlorobis(η -cyclopentadienyl)-(trimethylstannylmethyl)titanium(IV) (0.153 g, 0.391 mmol) in diethyl ether (50 cm³) was stirred at 20 °C with anhydrous sodium bromide (4.02 g, 39.1 mmol) for 22 h. Volatiles were removed *in vacuo* and the residue extracted with benzene and filtered. Hydrogen-1 n.m.r. spectra showed that the solution contained dibromobis(η -cyclopentadienyl)titanium(IV) (27%), bromobis(η -cyclopentadienyl)-(trimethylstannylmethyl)titanium(IV) (24%), and unchanged starting material (49%).

(e) *The reaction of chlorobis(η -cyclopentadienyl)-(trimethylstannylmethyl)titanium(IV) with anhydrous sodium bromide in methanol.* A solution of chlorobis(η -cyclopentadienyl)-(trimethylstannylmethyl)titanium(IV) (0.289 g, 0.738 mmol) in dry methanol (20 cm³) was stirred at 20 °C with anhydrous sodium bromide (0.080 g, 0.775 mmol) for 30 min. Volatiles were removed *in vacuo* and the residue extracted with benzene and filtered. A ¹H n.m.r. spectrum of the filtrate showed that, although extensive decomposition of the starting material had occurred (*ca.* 50%), a negligible amount of halide exchange had occurred.

Synthesis of Metallocene(IV) Dialkyls (15)–(30).—Only selected typical examples are described; further details are in Tables 2 and 4.

(a) $[\text{Ti}(\eta\text{-C}_5\text{H}_5)_2(\text{CH}_2\text{SnMe}_3)_2]$. A solution of trimethylstannylmethylmagnesium chloride (0.269 mol dm⁻³, 8.80 mmol) in diethyl ether (32.8 cm³) was added during 1 h to a stirred suspension of dichlorobis(η -cyclopentadienyl)titanium(IV) (0.996 g, 4.00 mmol) in diethyl ether (75 cm³) at 20 °C. The red dichloride slowly dissolved on addition of the Grignard reagent to form a red solution. After stirring at room temperature for 50 h, solvents were removed

in vacuo and the orange filtrate was concentrated to *ca.* 25 cm³ and cooled to -20 °C. The resulting crystals were filtered off while cold, and dried *in vacuo* to give bright yellow crystals of the *product* (1.67 g, 78%).

This compound was also prepared, by similar methods, from the action of trimethylstannylmethylmagnesium chloride on chloro- or bromo-bis(η -cyclopentadienyl)-(trimethylstannylmethyl)titanium(IV), or from the action of trimethylstannylmethylmagnesium bromide on either chloro- or bromo-bis(η -cyclopentadienyl)-(trimethylstannylmethyl)titanium(IV) or on dichlorobis(η -cyclopentadienyl)titanium(IV).

(b) $[\text{Zr}(\eta\text{-C}_5\text{H}_5)_2(\text{CH}_2\text{SnMe}_3)_2]$. A solution of trimethylstannylmethylmagnesium bromide (0.191 mol dm⁻³, 8.80 mmol) in diethyl ether (46.0 cm³) was added during 40 min to a stirred suspension of dichlorobis(η -cyclopentadienyl)-zirconium(IV) (1.17 g, 4.00 mmol) in diethyl ether (80 cm³) at 20 °C. The white suspension dissolved to form a yellow solution during addition. After stirring at room temperature for 46 h, solvents were removed *in vacuo* and the yellow residue extracted with hexane (50 cm³) and filtered to form a pale yellow solution. This was concentrated to 25 cm³ and cooled to -20 °C. The resulting crystals were filtered off while cold and dried *in vacuo* to give white needles of the *product* (1.52 g, 66%).

(c) $[\text{Ti}(\eta\text{-C}_5\text{H}_5)_2(\text{CH}_2\text{SnMe}_3)(\text{CH}_2\text{SiMe}_3)]$. A solution of trimethylsilylmethyl-lithium (0.50 mol dm⁻³, 2.20 mmol) in hexane (4.4 cm³) was added during 30 min to a stirred solution of chlorobis(η -cyclopentadienyl)-(trimethylstannylmethyl)titanium(IV) (0.783 g, 2.00 mmol) in benzene (20 cm³) at 10 °C. The deep red solution lightened in colour during addition to orange. After stirring at room temperature for 4 h, solvents were removed *in vacuo*, and the red residue extracted with hexane (25 cm³) and filtered. The yellow-orange filtrate was concentrated to *ca.* 15 cm³ and cooled to -20 °C. The resulting crystals were filtered off while cold and dried *in vacuo* to give bright yellow needles of the *product* (0.549 g, 62%).

(d) $[\text{Ti}(\eta\text{-C}_5\text{H}_5)_2(\text{CH}_2\text{SnMe}_3)(\text{CH}_2\text{CMe}_3)]$. A solution of neopentyl-lithium (0.110 mol dm⁻³, 2.67 mmol) in hexane (20.6 cm³) was added during 30 min to a stirred solution of bromobis(η -cyclopentadienyl)-(trimethylstannylmethyl)titanium(IV) (0.941 g, 2.16 mmol) in hexane (40 cm³) at 0 °C. The experiment was carried out under a darkened hood to exclude light. The deep red hexane solution darkened in colour during the addition. After stirring at room temperature for 2 h, the solution was concentrated to *ca.* 20 cm³ and cooled to -20 °C. The resulting crystals were filtered off, dried *in vacuo*, and recrystallised from hexane (15 cm³) to form dark red, shiny crystals of the *product* (0.674 g, 73%). The filtrations and recrystallisations were carried out in vessels covered in aluminium foil to exclude light.

(e) $[\text{Ti}(\eta\text{-C}_5\text{H}_5)_2(\text{CH}_2\text{SiMe}_3)(\text{CH}_2\text{GeMe}_3)]$. A solution of trimethylgermylmethyl-lithium (0.180 mol dm⁻³, 6.64 mmol) in diethyl ether (36.9 cm³) was added during 30 min to a stirred solution of chlorobis(η -cyclopentadienyl)-(trimethylsilylmethyl)titanium(IV) (1.95 g, 6.48 mmol) in diethyl ether (50 cm³) at 0 °C. The red solution became yellow during addition. After stirring at room temperature for 2 h, solvents were removed *in vacuo*, and the yellow residue extracted with hexane (70 cm³), and filtered. The bright yellow filtrate was concentrated to 30 cm³ and cooled to -20 °C. The resulting crystals were filtered off, washed with a little cold hexane, and dried *in vacuo* to give primrose-yellow needles of the *product* (1.90 g, 74%).

(f) $[\text{Zr}(\eta\text{-C}_5\text{H}_5)_2(\text{CH}_2\text{SnMe}_3)(\text{CH}_2\text{SiMe}_3)]$. A solution of trimethylsilylmethyl-lithium ($0.474 \text{ mol dm}^{-3}$, 1.98 mmol) in diethyl ether (4.18 cm^3) was added during 30 min to a stirred solution of bromobis(η -cyclopentadienyl)(trimethylstannylmethyl)zirconium(IV) (0.864 g , 1.80 mmol) in diethyl ether (35 cm^3) at 20°C . During addition, the solution became yellow and, after stirring at room temperature for 3 h, a colourless solution was formed. Solvents were removed *in vacuo* and the white residue extracted with hexane (18 cm^3), and filtered. The colourless filtrate was concentrated to *ca.* 10 cm^3 and cooled to -20°C . The resulting crystals were filtered off while cold and dried *in vacuo* to give white needles of the product (0.681 g , 78%).

(g) $[\text{Hf}(\eta\text{-C}_5\text{H}_5)_2(\text{CH}_2\text{SnMe}_3)(\text{CH}_2\text{SiMe}_3)]$. A solution of trimethylsilylmethyl-lithium ($0.474 \text{ mol dm}^{-3}$, 1.42 mmol) in diethyl ether (2.99 cm^3) was added during 30 min to a stirred solution of chlorobis(η -cyclopentadienyl)(trimethylstannylmethyl)hafnium(IV) (0.672 g , 1.29 mmol) in diethyl ether (30 cm^3) at 20°C . The resulting colourless solution was stirred at room temperature for 2 h. Solvents were removed *in vacuo* and the white residue extracted with hexane (20 cm^3). The colourless filtrate was concentrated to *ca.* 8 cm^3 and cooled to -20°C . The resulting crystals were filtered off and dried *in vacuo* to give white needles of the product (0.677 g , 83%).

Preparation of $[\text{Ti}(\eta\text{-C}_5\text{H}_5)_2\text{Cl}(\text{OCH}_2\text{SiMe}_3)]$, (14).—A sample of trimethylsilylmethyl-lithium had been exposed to air and had reacted in part to form trimethylsilylmethoxy-lithium. This solution was added dropwise to a stirred suspension of dichlorobis(η -cyclopentadienyl)titanium(IV) (0.747 g , 3.00 mmol) in diethyl ether (30 cm^3) at 20°C , until the colour had lightened to yellow-orange and all the reagents were in solution. After stirring at room temperature for 1 h, solvents were removed *in vacuo* and the residue extracted with hexane (25 cm^3) and filtered. The yellow-orange filtrate was concentrated to *ca.* 10 cm^3 and cooled to -20°C . The resulting crystals were filtered off, washed with cold hexane, and dried *in vacuo* to give primrose-yellow needles of the product (0.589 g , 62%). No other hexane-soluble products were obtained from this reaction.

Reaction of Chlorobis(η -cyclopentadienyl)(trimethylstannylmethyl)titanium(IV) with Ethereal Hydrogen Chloride.—A solution of hydrogen chloride (0.17 mol dm^{-3} , 1.02 mmol) in diethyl ether (6.00 cm^3) was added during 20 min to a stirred solution of chlorobis(η -cyclopentadienyl)(trimethylstannylmethyl)titanium(IV) (0.419 g , 1.07 mmol) in diethyl ether (20 cm^3) at 20°C . The mixture was stirred for a further 40 min, and the volatiles removed *in vacuo*. Hydrogen-1 n.m.r. spectra of the product, a red solid, showed it to contain dichlorobis(η -cyclopentadienyl)titanium(IV) (79%) and chlorobis(η -cyclopentadienyl)methyltitanium(IV) (21%). The latter product was also isolated by fractional recrystallisation and characterised by microanalysis. Investigation of the volatile products of this reaction showed the presence of chlorotrimethylstannane and tetramethylstannane in a ratio of *ca.* 1 : 4.

Reactions of Metallocene(IV) Dialkyls with Ethereal Hydrogen Chloride.—Only selected examples are given; further data are in Table 5 and in ref. 3.

(a) $[\text{Ti}(\eta\text{-C}_5\text{H}_5)_2(\text{CH}_2\text{SnMe}_3)_2]$. A solution of hydrogen chloride (0.17 mol dm^{-3} , 1.02 mmol) in diethyl ether (6.00 cm^3) was added during 20 min to a stirred solution of the dialkyl (0.544 g , 1.02 mmol) in diethyl ether (20 cm^3) at 20°C . The mixture was stirred for a further 40 min at 20°C and the volatiles removed *in vacuo*. Hydrogen-1

n.m.r. spectra of the product, a red solid, showed it to contain chlorobis(η -cyclopentadienyl)(trimethylstannylmethyl)titanium(IV) (94%), unreacted dialkyl (4%), dichlorobis(η -cyclopentadienyl)titanium(IV) (1%), and bis(η -cyclopentadienyl)methyl(trimethylstannylmethyl)titanium(IV) (1%).

(b) $[\text{Zr}(\eta\text{-C}_5\text{H}_5)_2(\text{CH}_2\text{SiMe}_3)_2]$. A solution of hydrogen chloride ($0.137 \text{ mol dm}^{-3}$, 0.303 mmol) in diethyl ether (2.21 cm^3) was added during 20 min to a stirred solution of the dialkyl (0.120 g , 0.303 mmol) in diethyl ether (10 cm^3) at 20°C . The mixture was stirred for a further 40 min at 20°C and the volatiles removed *in vacuo*. Hydrogen-1 n.m.r. spectra of the product, a white solid, showed it to contain chlorobis(η -cyclopentadienyl)(trimethylsilylmethyl)zirconium(IV) (92%), unreacted dialkyl (6%), and dichlorobis(η -cyclopentadienyl)zirconium(IV) (2%).

Chlorobis(η -cyclopentadienyl)(trimethylsilylmethyl)zirconium(IV) is extremely sensitive to traces of moisture. Consequently all solvents were thoroughly dried and degassed before use, and the ethereal hydrogen chloride was freshly prepared from dried solvent. In a similar reaction to that above, using an older sample of ethereal hydrogen chloride, the products obtained were unreacted dialkyl (4%), dichlorobis(η -cyclopentadienyl)zirconium(IV) (2%), chlorobis(η -cyclopentadienyl)(trimethylsilylmethyl)zirconium(IV) (44%), and μ -oxo-bis[chlorodi(η -cyclopentadienyl)zirconium(IV)] (50%). The latter product (Found: C, 44.7 ; H, 3.90 ; Cl, 13.1 . Calc. for $\text{C}_{20}\text{H}_{20}\text{Cl}_2\text{OZr}_2$: C, 45.3 ; H, 3.80 ; Cl, 13.4%) was isolated from the product mixture and characterised by ^1H n.m.r. and i.r. spectra.

(c) $[\text{Ti}(\eta\text{-C}_5\text{H}_5)_2(\text{CH}_2\text{SnMe}_3)(\text{CH}_2\text{GeMe}_3)]$. A solution of hydrogen chloride (0.17 mol dm^{-3} , 0.588 mmol) in diethyl ether (3.46 cm^3) was added during 20 min to a stirred solution of the dialkyl (0.287 g , 0.588 mmol) in diethyl ether (15 cm^3) at 20°C . The mixture was stirred for a further 40 min at 20°C and the volatiles removed *in vacuo*. Hydrogen-1 n.m.r. spectra of the orange solid product showed it to contain chlorobis(η -cyclopentadienyl)(trimethylstannylmethyl)titanium(IV) (14%), chlorobis(η -cyclopentadienyl)(trimethylgermylmethyl)titanium(IV) (76%), unreacted dialkyl (8%), and dichlorobis(η -cyclopentadienyl)titanium(IV) (2%). Fractional recrystallisation of the solid residue, from benzene-hexane mixtures, gave pale orange needles of chlorobis(η -cyclopentadienyl)(trimethylgermylmethyl)titanium(IV) (0.034 g).

Reaction of Bis(η -cyclopentadienyl)(trimethylsilylmethyl)(trimethylstannylmethyl)titanium(IV) with Ethereal Hydrogen Bromide.—A solution of hydrogen bromide ($0.051 \text{ mol dm}^{-3}$, 0.794 mmol) in diethyl ether (1.56 cm^3) was added during 20 min to a stirred solution of the dialkyl (0.0352 g , 0.0794 mmol) in diethyl ether (10 cm^3) at 20°C . The mixture was stirred for a further 40 min, and the volatiles removed *in vacuo*. Hydrogen-1 n.m.r. spectra of the orange product showed it to contain bromobis(η -cyclopentadienyl)(trimethylsilylmethyl)titanium(IV) (59%), bromobis(η -cyclopentadienyl)(trimethylstannylmethyl)titanium(IV) (12%), unreacted dialkyl (25%), and dibromobis(η -cyclopentadienyl)titanium(IV) (4%).

Thermal Decomposition, in Benzene Solution at 80°C , of the Metallocene(IV) Dialkyls.—The appropriate dialkyl (15), (21), (29), or $[\text{M}(\eta\text{-C}_5\text{H}_5)_2(\text{CH}_2\text{SiMe}_3)_2]$ ($\text{M} = \text{Ti}$ or Zr) was recrystallised several times from hexane, dried, and introduced into an n.m.r. tube under argon. Dried, degassed benzene, containing a toluene reference, was distilled onto each sample *in vacuo*, and the n.m.r. tube was sealed off and heated to 80°C in a constant temperature

bath in the absence of light. Hydrogen-1 n.m.r. spectra of the solutions were run at regular intervals and times for 50% decomposition determined by comparing the integrals of starting material peaks with that of the toluene reference. Only the two titanium compounds decomposed (the others were unchanged after 160 h at 80 °C) to deposit an insoluble brown residue on the walls of the tube; the organic decomposition product was $M'Me_4$ ($M' = Si$, 1.5 mol; or $M' = Sn$, 1.6 mol) and $t_{1/2}$ was 110 min ($M' = Si$) or 140 min ($M' = Sn$).

Insertion of CO into $[Zr(\eta-C_5H_5)_2RX]$.—An outline of the carbon monoxide insertion reactions is provided by the characterisation of the zirconocene(IV) acyls (31)–(35) described in Table 3. Further details of two typical experiments are provided below.

(a) $[Zr(\eta-C_5H_5)_2\{CH(SiMe_3)_2\}Me]$. A solution of the mixed dialkyl (23) (ca. 1 g) was stirred in benzene (ca. 5 cm³) under 1 atm of CO at ambient temperature for 10 d. Removal of solvent *in vacuo* and recrystallisation of the residue (100%) from a CH_2Cl_2 –OEt₂ mixture yielded very pale yellow crystals of the acyl (35) (Table 3).

(b) $[Zr(\eta-C_5H_5)_2(CH_2CMe_3)_2]$. A solution of the dialkyl (28) (0.65 g, 1.8 mmol) in benzene (10 cm³) was treated as in (a) for 24 h. Removal of solvent *in vacuo* and recrystallisation from $n-C_6H_{14}$ at –30 °C gave yellow crystals of the acyl (33) (85%) (Table 3).

Crystal Data.— $C_{20}H_{32}Zr$, (28). $M = 363.7$, Tetragonal, $a = 9.142(4)$, $b = 9.142(4)$, $c = 23.326(9)$ Å, $\beta = 90^\circ$, $U = 1949.5$ Å³, $D_c = 1.24$ g cm⁻³, $Z = 4$, $\mu(Mo-K\alpha) = 5.5$ cm⁻¹, $F(000) = 768$, $\lambda(Mo-K\alpha) = 0.71069$ Å, space group $I\bar{4}$.

$C_{18}H_{22}Si_2Zr$, (42). $M = 395.8$, Monoclinic, $a = 13.745(6)$, $b = 7.048(3)$, $c = 22.057(9)$ Å, $\beta = 95.65(4)^\circ$, $U = 2126.3$ Å³, $D_c = 1.23$ g cm⁻³, $Z = 4$, $\mu(Mo-K\alpha) = 6.1$ cm⁻¹, $F(000) = 832$, $\lambda(Mo-K\alpha) = 0.71069$ Å, space group $P2_1/n$. The lattice parameters were determined from a least-squares refinement of the angular settings of 15 reflections ($2\theta > 40^\circ$) accurately centred on an Enraf–Nonius CAD-4 diffractometer.

X-Ray Data Collection for $[Zr(\eta-C_5H_5)_2(CH_2CMe_3)_2]$, (28).—A crystal of dimensions $0.23 \times 0.38 \times 0.69$ mm was sealed in a thin-walled capillary under a dinitrogen atmosphere. Data were taken on the diffractometer using graphite-monochromated molybdenum radiation. The diffracted intensities were collected by the ω – 2θ scan technique in a manner similar to that described previously.²⁷ All the reflections out to $2\theta = 50^\circ$ were measured, 487 being considered observed [$I > 3\sigma(I)$]. The intensities were corrected for Lorentz and polarisation effects, but not for absorption. Full-matrix least-squares refinement was carried out using the Sheldrick SHELX program.* The function $\omega(|F_o| - |F_c|)^2$ was minimised. No corrections were made for extinction. Atomic scattering factors for Zr and C were taken from Cromer and Waber,²⁸ whereas those for H were taken from ref. 29. Corrections for the real and imaginary components of anomalous dispersion were used only for Zr, the values being those of Cromer and Liberman.³⁰

X-Ray Data Collection for $[Zr(\eta-C_5H_5)_2(CH_2SiMe_3)_2]$, (42).—Following the data collection procedures given above, 2688 independent reflections were observed from a crystal of dimensions $0.21 \times 0.35 \times 0.87$ mm.

Structure Determination and Refinement for Complex (28).—

* Other crystallographic programs used on a UNIVAC 1110 include ORTEP (thermal ellipsoid drawings, by C. K. Johnson) and BPL (least-squares planes, by W. E. Hunter).

The position of the zirconium atom was revealed *via* Patterson-map inspection, and calculation of a Fourier map phased on the metal atom led to the co-ordinates of the remaining 10 non-hydrogen atoms. After several cycles of least-squares refinement with at first isotropic and then anisotropic thermal parameters, the cyclopentadienyl hydrogens and the hydrogen atoms on the α -carbon atom of the σ -bound ligand were placed in calculated positions. The hydrogen atoms on the methyl groups were treated as rigid groups in the standard manner available in the SHELX system. Further refinement of the non-hydrogen atoms led to final values of $R = \Sigma(|F_o| - |F_c|)/\Sigma|F_o| = 0.029$ and $R' = [\Sigma(|F_o| - |F_c|)^2/\Sigma(F_o)^2]^{1/2} = 0.032$. The estimated standard deviation of an observation of unit weight was 1.49. Unit weights were used throughout the refinement. The largest parameter shifts in the final cycle were less than 0.02 of their e.s.d. and no unaccountable electron density was shown by the final difference Fourier. No systematic variation of $\omega(|F_o| - |F_c|)$ against $|F_o|$ or $(\sin \theta)/\lambda$ was noted. The final values of the positional parameters are given in Table 8, while bond lengths and angles are given in Table 6.

TABLE 8

Atomic positions in fractional co-ordinates for $[Zr(\eta-C_5H_5)_2(CH_2CMe_3)_2]$, (28) (X = C), with estimated standard deviations in parentheses

Atom	x/a	y/b	z/c
Zr	0.000 0	-0.500 0	-0.094 25(4)
C(1)	-0.125(1)	-0.374(1)	-0.163 9(3)
X(1)	-0.243(1)	-0.259(1)	-0.172 7(3)
C(2)	-0.385(1)	-0.299(2)	-0.143 4(7)
C(3)	-0.199(2)	-0.112(1)	-0.145 2(7)
C(4)	-0.264(1)	-0.235(2)	-0.237 6(5)
C(5)	-0.237(2)	-0.637(2)	-0.086 8(9)
C(6)	-0.136(3)	-0.742(2)	-0.086 8(8)
C(7)	-0.056(2)	-0.732(3)	-0.040(1)
C(8)	-0.114(5)	-0.625(5)	-0.008 7(4)
C(9)	-0.221(3)	-0.564(2)	-0.039(1)
H(1)	-0.037 5	-0.325 6	-0.185 2
H(2)	-0.158 2	-0.456 9	-0.189 2
H(3)	-0.404 0	-0.407 2	-0.165 6
H(4)	-0.373 9	-0.308 5	-0.202 7
H(5)	-0.474 6	-0.228 7	-0.158 1
H(6)	-0.121 0	-0.099 3	-0.177 9
H(7)	-0.275 0	-0.022 5	-0.143 8
H(8)	-0.146 3	-0.123 2	-0.103 6
H(9)	-0.167 6	-0.196 3	-0.255 6
H(10)	-0.307 5	-0.327 6	-0.263 4
H(11)	-0.348 4	-0.153 1	-0.235 5
H(12)	-0.308 0	-0.617 6	-0.118 6
H(13)	-0.123 5	-0.818 3	-0.117 0
H(14)	0.033 9	-0.788 3	-0.028 8
H(15)	-0.086 7	-0.587 5	0.030 5
H(16)	-0.286 8	-0.478 9	-0.028 6

The observed and calculated structure factor amplitudes and thermal parameters are given in Supplementary Publication No. SUP 23048 (24 pp.).*

Structure Determination and Refinement for Complex (42).—The procedure was the same as for the neopentyl compound except for the hydrogen-atom location. Cyclopentadienyl hydrogen atoms were placed in calculated positions and were not subsequently varied, whereas all other hydrogen atoms were located from a difference-Fourier map and their parameters were refined for three cycles and then fixed. This led to final values of $R = 0.029$ and $R' = 0.033$ with unit weights being used throughout the refinement. The estimated standard deviation of an

* For details see Notices to Authors No. 7, *J. Chem. Soc., Dalton Trans.*, 1980, Index issue.

observation of unit weight was 1.25. The largest parameter shifts in the last cycle were less than 0.01 of their e.s.d.s. Final observations were the same as for the neopentyl compound and all resulting information is given in the corresponding Tables and SUP 23048.

TABLE 9

Atomic positions in fractional co-ordinates for $[\text{Zr}(\eta\text{-C}_5\text{H}_5)_2(\text{CH}_2\text{SiMe}_3)_2]$, (42) (X = Si), with estimated standard deviations in parentheses

Atom	x/a	y/b	z/c
Zr	-0.020 84(2)	0.182 42(5)	0.210 11(2)
X(1)	-0.166 14(9)	0.370 7(2)	0.066 24(5)
X(2)	0.064 22(9)	0.365 4(2)	0.368 43(5)
C(1A)	-0.094 2(3)	0.391 1(6)	0.141 2(2)
C(2A)	-0.291 2(4)	0.274 5(9)	0.071 2(2)
C(3A)	-0.107 7(4)	0.233(1)	0.011 6(3)
C(4A)	-0.185 2(5)	0.610(1)	0.031 0(3)
C(1B)	0.016 3(3)	0.391 8(5)	0.287 8(2)
C(2B)	-0.030 9(4)	0.289 7(9)	0.417 2(2)
C(3B)	0.166 0(4)	0.188 9(9)	0.380 7(2)
C(4B)	0.114 5(5)	0.594 7(9)	0.399 5(3)
C(5A)	0.142 1(4)	0.264 7(9)	0.169 8(3)
C(6A)	0.093 1(4)	0.147(1)	0.126 6(2)
C(7A)	0.083 6(4)	-0.029(1)	0.152 6(3)
C(8A)	0.127 8(4)	-0.020(1)	0.211 0(3)
C(9A)	0.164 1(3)	0.159(1)	0.221 7(3)
C(5B)	-0.199 2(3)	0.105 9(7)	0.220 4(2)
C(6B)	-0.153 0(3)	0.102 9(7)	0.278 7(2)
C(7B)	-0.086 6(3)	-0.044 7(7)	0.283 3(2)
C(8B)	-0.093 8(4)	-0.136 8(6)	0.227 4(3)
C(9B)	-0.162 1(3)	-0.041 2(7)	0.187 6(2)
H(1A)	-0.132 6	0.454 1	0.168 5
H(2A)	-0.038 7	0.475 4	0.135 8
H(1B)	-0.041 2	0.455 7	0.285 9
H(2B)	0.059 0	0.480 6	0.264 8
H(3)	0.159 4	0.404 8	0.163 8
H(4)	0.067 0	0.184 6	0.083 2
H(5)	0.049 7	-0.146 3	0.131 1
H(6)	0.132 6	-0.130 6	0.242 3
H(7)	0.200 1	0.208 6	0.261 8
H(8)	-0.251 8	0.200 0	0.203 6
H(9)	-0.166 0	0.194 8	0.313 1
H(10)	-0.039 9	-0.079 6	0.321 0
H(11)	-0.055 9	-0.255 0	0.217 2
H(12)	-0.180 2	-0.071 7	0.142 4
H(13)	-0.333 3	0.294 9	0.031 8
H(14)	-0.318 9	0.325 2	0.105 5
H(15)	-0.282 5	0.139 3	0.081 9
H(16)	-0.143 2	0.221 2	-0.025 2
H(17)	-0.097 1	0.097 0	0.031 9
H(18)	-0.043 9	0.263 9	0.010 2
H(19)	-0.220 1	0.616 3	-0.007 0
H(20)	-0.224 6	0.695 1	0.057 4
H(21)	-0.118 9	0.669 2	0.028 7
H(22)	-0.009 8	0.282 6	0.457 4
H(23)	-0.083 0	0.379 1	0.411 3
H(24)	-0.059 0	0.169 5	0.402 0
H(25)	0.210 6	0.213 3	0.359 0
H(26)	0.189 9	0.178 9	0.420 7
H(27)	0.140 9	0.064 2	0.362 5
H(28)	0.146 0	0.588 6	0.437 9
H(29)	0.060 9	0.672 3	0.401 8
H(30)	0.161 0	0.640 3	0.368 0

We thank the S.R.C. for the award of a studentship (to M. W.), a fellowship (to J. J.) and other support, the U.S.

National Science Foundation for partial support (to J. L. A.), Mr. G. S. Bristow for a useful discussion, and Dr. M. J. S. Gynane for the crystal of complex (42) used for X-ray analysis.

[0/1938 Received, 16th December, 1980]

REFERENCES

- Part 3, M. F. Lappert, P. I. Riley, P. I. W. Yarrow, J. L. Atwood, W. E. Hunter, and M. J. Zaworotko, *J. Chem. Soc., Dalton Trans.*, 1981, 814.
- cf.*, P. J. Davidson, M. F. Lappert, and R. Pearce, *Acc. Chem. Res.*, 1974, **7**, 209.
- cf.*, M. Webb, D.Phil. Thesis, University of Sussex, 1975.
- M. M. Truelock, D.Phil. Thesis, University of Sussex, 1970.
- M. R. Collier, M. F. Lappert, and M. M. Truelock, *J. Organomet. Chem.*, 1970, **25**, C36.
- D. Seyferth, *J. Am. Chem. Soc.*, 1959, **81**, 1844.
- M. R. Collier, B. M. Kingston, and M. F. Lappert, *Chem. Commun.*, 1970, 1498.
- R. B. King and K. C. Hodges, *J. Organomet. Chem.*, 1974, **65**, 77.
- R. B. King, K. H. Pannell, C. R. Bennett, and M. Ishaq, *J. Organomet. Chem.*, 1969, **19**, 327.
- M. F. Lappert, N. T. Luong-Thi, and C. R. C. Milne, *J. Organomet. Chem.*, 1979, **174**, C35.
- M. F. Lappert, D. S. Patil, and J. B. Pedley, *J. Chem. Soc., Chem. Commun.*, 1975, 830.
- J. Jeffery, M. F. Lappert, N. T. Luong-Thi, J. L. Atwood, and W. E. Hunter, *J. Chem. Soc., Chem. Commun.*, 1978, 1081.
- H. C. Beachell and S. A. Butter, *Inorg. Chem.*, 1965, **4**, 1133.
- M. D. Rausch, *Inorg. Chem.*, 1964, **2**, 300.
- cf.*, G. A. Razuvaev, V. N. Latyaeva, and L. I. Vyshinskaya, *Zh. Obshch. Khim.*, 1961, **31**, 2667; A. N. Nesmeyanov and O. V. Nogina, *ibid.*, p. 2667.
- M. R. Collier, M. F. Lappert, and R. Pearce, *J. Chem. Soc., Dalton Trans.*, 1973, 445.
- E. Fachinetti and C. Floriani, *J. Chem. Soc., Chem. Commun.*, 1972, 654.
- G. Fachinetti, G. Fochi, and C. Floriani, *J. Chem. Soc., Dalton Trans.*, 1977, 1946.
- G. Erker and F. Rosenfeldt, *Angew. Chem., Int. Ed. Engl.*, 1978, **17**, 605; *J. Organomet. Chem.*, 1980, **188**, C1; G. Erker and K. Kropp, *ibid.*, 1980, **194**, 45.
- W. E. Hunter, D. C. Hrcir, R. V. Bynum, R. A. Penttila, and J. L. Atwood, *Inorg. Chem.*, in the press.
- E. F. Epstein and I. Bernal, *J. Organomet. Chem.*, 1971, **26**, 229; B. R. Davis and I. Bernal, *ibid.*, 1971, **30**, 75; C. H. Saldrarriaga-Molina, A. Clearfield, and I. Bernal, *ibid.*, 1974, **80**, 79.
- C. Johnson, J. Toney, and G. D. Stucky, *J. Organomet. Chem.*, 1972, **40**, C11.
- J. L. Atwood, W. E. Hunter, D. C. Hrcir, E. Samuel, H. Alt, and M. D. Rausch, *Inorg. Chem.*, 1975, **14**, 1757.
- J. L. Atwood, G. K. Barker, J. Holton, W. E. Hunter, M. F. Lappert, and R. Pearce, *J. Am. Chem. Soc.*, 1977, **99**, 6645.
- M. A. Bush and G. A. Sim, *J. Chem. Soc. A*, 1971, 2225.
- R. D. Rogers, R. V. Bynum, and J. L. Atwood, *J. Am. Chem. Soc.*, 1978, **100**, 5238.
- J. Holton, M. F. Lappert, D. G. H. Ballard, R. Pearce, J. L. Atwood, and W. E. Hunter, *J. Chem. Soc., Dalton Trans.*, 1979, 45.
- D. T. Cromer and J. T. Waber, *Acta Crystallogr.*, 1965, **18**, 104.
- 'International Tables for X-Ray Crystallography,' Kynoch Press, Birmingham, 1962, vol. 3.
- D. T. Cromer and D. Liberman, *J. Chem. Phys.*, 1970, **53**, 1891.